

ULTRASONIC LEVEL TRANSDUCER
ULT20



USER'S MANUAL



Contents

1 Application.....	3
2 Transducer set.....	4
3 Basic requirements, operational safety	5
4 Installation	6
4.1 Method of installation	6
4.2 External connections diagram	7
4.3 Examples of applications.....	9
5 Operation	11
5.1 Description of front panel	11
5.2 Functions of buttons	12
5.3 Transducer parameters programming	14
5.3.1 Changing value of selected parameter	16
5.3.2 Programmable transducer parameters	17
5.4 Functions of the transducer	23
5.4.1 Distance measurement	23
5.4.1.1 Measured value averaging	24
5.4.1.2 Minimum and maximum measured values	24
5.4.1.3 Individual characteristics	25
5.4.1.4 Counter.....	26
5.4.2 Analog output	26
5.4.3 Binary pulse output	27
5.4.4 Alarm outputs	28
5.4.5 LCD display	29
5.5 Factory settings.....	31
5.6 Archiving	33
5.6.1 Structure of record	34
5.6.2 Measured values archiving	35
5.6.3 Events archiving	36
5.6.4 Downloading archived data	38
5.7 RS-485 interface	39
5.7.1 Connection	40
5.7.2 Description of MODBUS protocol implementation.	41
5.7.3 Implemented functions of MODBUS protocol	41
5.7.4 Map of registers	41
5.7.4.1 Registers 4000 – 4081.....	42
5.7.4.2 Registers 4300 – 4435.....	48
5.7.4.3 Registers 5000 – 5272.....	53
5.7.4.4 Registers 7500 – 7533 and 8000 – 8065	53
5.7.4.5 Registers 7800 – 7949 and 8200 – 8498.....	55
5.8 USB interface	59
6 Error codes	60
7 Technical data	61
8 Ordering code	63

1 Application

Ultrasonic level transducer ULT20 are designed to measure distance, and after programming functions which process the measured value of distance they can be used to measure the filling of tanks, silos, to count the flow and level measurement in open channels and wherever there is a need to measure the distance as a basic measured value. Additional interfaces and additional equipment in the form of programmable alarms allow for the measured data transmission and recording and local control based on event system. Built-in LCD display, which, together with the keyboard creates a local user interface allows for any change of operating parameters and viewing the current status of the device, including the reading of measured values.

Built-in memory of events and archived data storage allow for archiving of status of ULT20 transducer operation. Archived data is available through the interfaces: RS485 and USB. At the same time, these interfaces can also be used for programming and monitoring of ULT20 transducer operation.

ULT20 transducers have a robust housing made of aluminum, which protects the transducer from external influences. View of ULT20 transducer is shown in Fig.1



Fig. 1: View of ULT20 transducer.

ULT20 transducers are characterized by:

- The measurement distance in the range of 0,5 ... 8 m with automatic temperature compensation (temperature sensor integrated in the measuring head).
- Analog output in 0/4 ... 20 mA standard with configurable output characteristics and configurable output control value with manual output control included.
- Two-wire RS485 interface in MODBUS standard.

- Two programmable alarms with NO contact. Each alarm can be configured to work in the selected mode and to response to any value measured together with the current time. In addition, a change in the position of the relay contact may be delayed by a programmed time. User can also activate the memory function of alarm activation.
- Galvanically separated counter binary output with programmable pulse weight.
- Built-in graphic LCD display and buttons for programming all functions of the transducer. In addition, using the display, the User can view all the measured values.
- Password protection of the transducer (settings) menu.
- Built-in galvanically isolated USB interface for configuration, viewing the status of the transducer and reading the archives.
- Built-in real time clock with automatic adjustment for Daylight Saving Time. In the absence of power supply the clock is supplied by an internal lithium battery.
- Built-in event memory allows for the registration of system events such as power failure, alarms activation or deactivation, etc.
- Built-in memory of archive data with a choice of recording in five independently configurable channels with any choice of the archived value and the value triggering archiving.
- Two 32-point individual characteristics allow the User to scale the measured value according to two different values, for example: the level and the flow.
- Registration of minimum and maximum values for all measured and calculated parameters with the date and time of occurrence.
- The possibility of averaging the measured value by moving average.
- The possibility of Individual assignment of units to the value calculated according to the desired individual characteristic.
- Built-in diagnostics function for continuous monitoring the operating status of the device.
- Aluminum housing with IP65 protection degree.
- Low supply voltage (operation from 12 V) and a wide range of supply voltage (12 ... 40 V) allowing for operation in a system powered with batteries.

2 Transducer set

The set of ULT20 transducer contains:

- ULT20 transducer 1 pc
- User's manual 1 pc
- Warranty Card 1 pc

3 Basic requirements, operational safety

ULT20 transducer, with respect to user's safety, complies with the requirements of EN 61010-1 standard.

Safety instructions



- The assembly and the installation of the electrical connections should be carried out by a duly qualified electrician.
- Before turning on the transducer verify the connections.
- The device is intended for installation and use in industrial electromagnetic environments.
- A switch or a circuit-breaker should be installed in the building or facility located near the device, easily accessible to the operator, and suitably marked.
- Disassembly of the transducer electronic system during the warranty period voids the warranty.

4 Installation

ULT20 transducers can be installed in any position. During installation it is recommended to avoid mounting with the sensor facing up, as it can cause severe deposition of contaminants on the sensor membrane and lead to measurement errors. During installation the sensor should be positioned in such a way that the **measuring head is perpendicular to the surface**, to which the distance is to be measured. The view and dimensions of ULT20 transducer are shown in Fig .2.

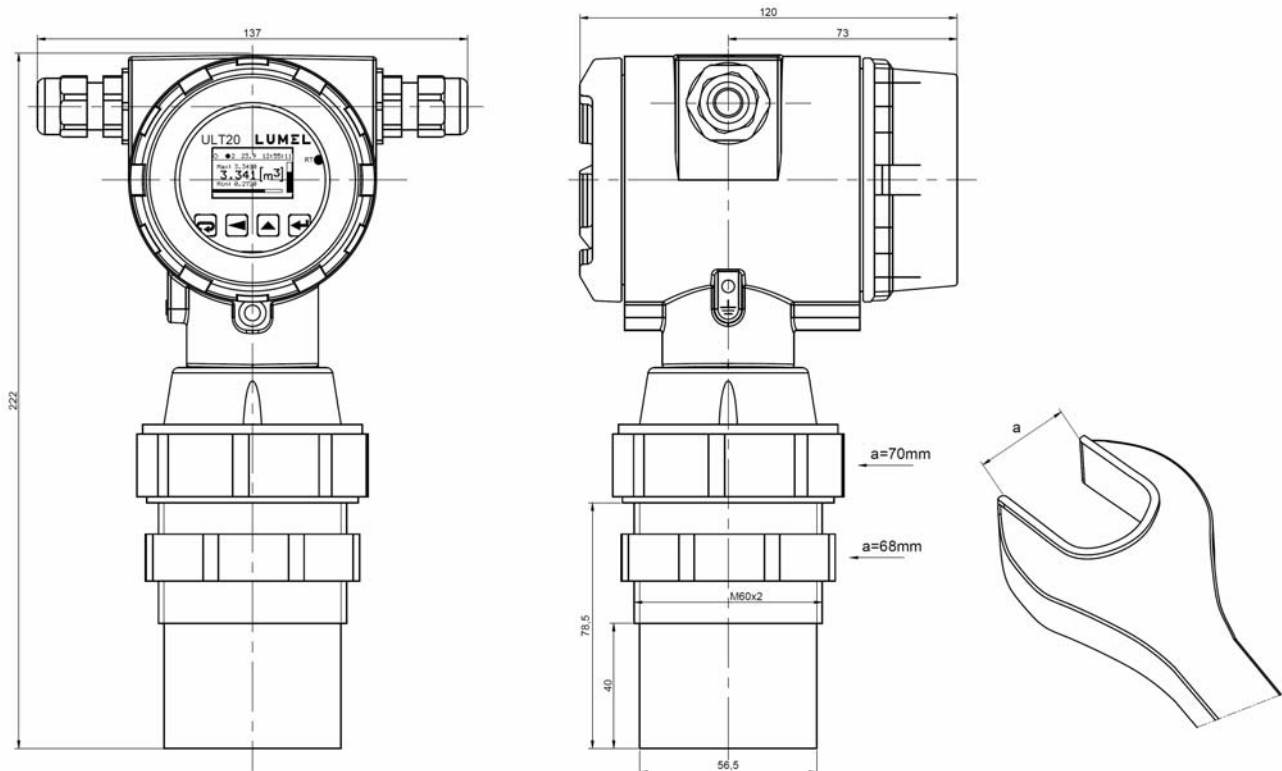

1. Fig. 2. View and dimensions of the transducer.

4.1 Method of installation

ULT20 transducers are designed for installation in a hole with a diameter of 60 to 65 mm. The maximum thickness of the material wherein the hole is formed is 20 mm.

On the outside of the sensor there is a M60x2 thread, which allows direct attachment of the sensor to the mounting bracket or to the flange mounted in the tank. Take special precautions to make sure that the sensor is not damaged during direct assembly in the threaded hole. Never screw or turn off the transducer by twisting the aluminum housing part .

Cable grommets located on the side of the housing are used for conductors connection. While connecting conductors, special care should be taken that no cable touches the con-

ductive part of the housing, or other cables. After completion of conductors connection the cable grommets should be tightened.

All circuits are galvanically isolated from other circuits. The exception is the power supply and interface for connecting the measuring head, which is not galvanically isolated from the power supply of the transducer. This is due to the fact that in some cases the terminal of the negative supply potential must be grounded in order to provide a stable indications. Other circuits, such as analog output, RS-485 interface, USB interface and alarm outputs are separated from each other and from power supply as shown in Fig. 3.

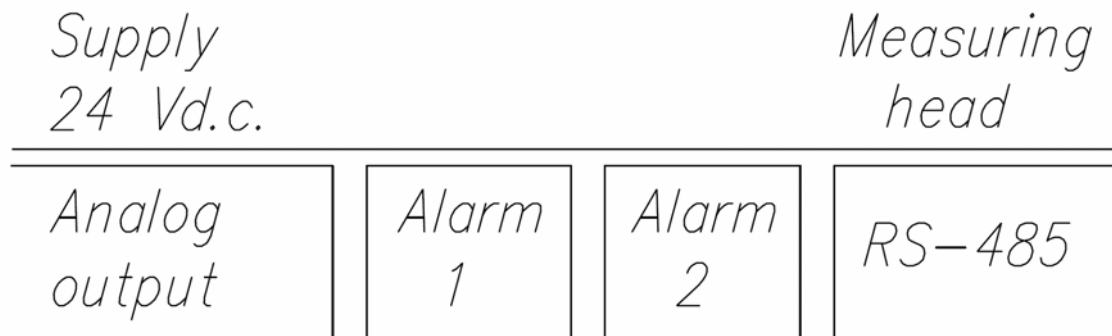

Fig. 3. Galvanic isolation in ULT20 transducer.

4.2 External connections diagram

ULT20 transducer is equipped with screw jacks for connecting conductors up to 1 mm² and 2 mm² for alarm signals terminal block. All external signals are routed to three slots. The first slot JE2 is used to connect signals: analog output and power supply. The second slot JE1 is used to connect signals: binary output and RS485 interface. The third slot includes terminals of alarm relay contacts. Access to the terminals is possible after removing the rear cover of the transducer. The terminal for USB port is located on the front panel of the transducer. The location of connectors and terminals description is shown in Fig. 4.

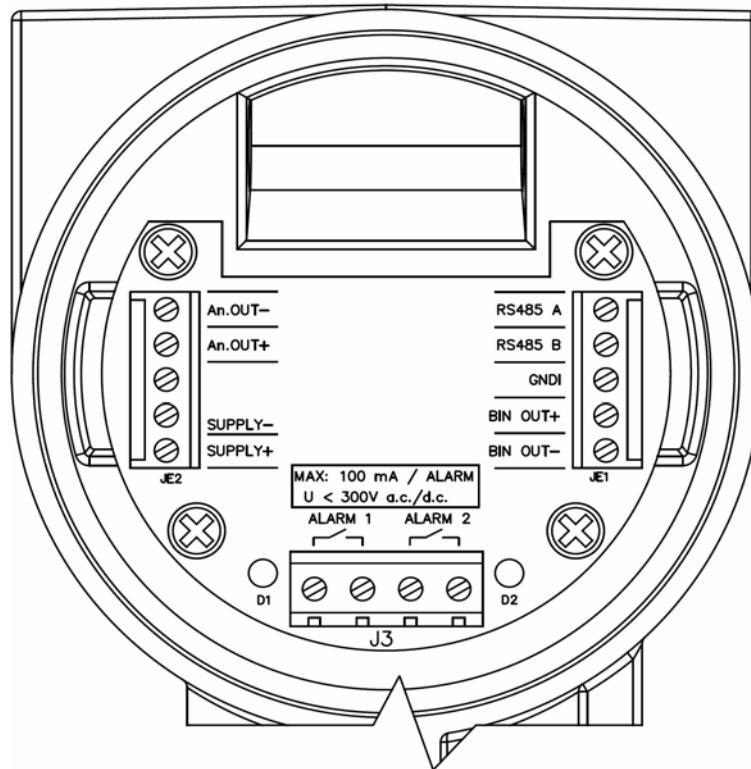

Fig. 4. Location of signal connectors.

Signal	Description
An.Out+, An.O-ut-	Analog current output: 0/4..20 mA.
SUPPLY+, SUPPLY-	Transducer supply terminal 12..40 V d.c.
RS485_A, RS485_B, GNDI	Interface signal RS485
BIN OUT+, BIN OUT-	Binary pulse output. Transistor output NPN, where <i>BIN OUT+</i> is transistor collector, and <i>BIN OUT-</i> to transistor emitter.
ALARM 1	Output of alarm 1 – semiconductor relay.
ALARM 2	Output of alarm 2 – semiconductor relay.

Note: The outside of the housing is equipped with a terminal to which the PE cable is to be connected. All shieldings of the signal cables should also be connected to this terminal.

When shielded cables are used, be sure to connect each cable shield at only one point.

4.3 Examples of applications

The following figure shows the examples of installation and usage of the ULT20 transducer in the application of a tank filling measurement and in the application of open channel level or flow measurement. Additionally, Fig. 6 presents an example of flow measurement in a channel using a venturi (bends) with a triangular cut-out. However, the flow measurement requires the use of appropriate tubes or separators.

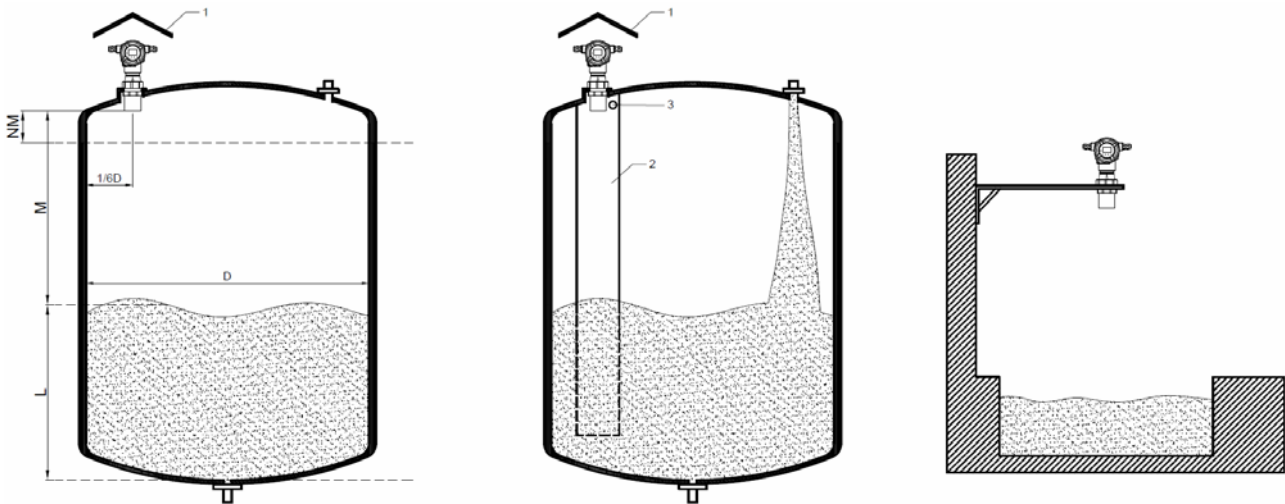

Fig. 5: Examples of installation.

Markings in Figure 5:

- NM – dead zone distance – zone in which there is no measurement or the distance value at which the tank is fully filled.
- M – distance between the measured medium and the measuring head.
- L – height (level) of the tank filling.
- D – tank diameter.
- 1 – weather cover mounted above the ULT20 transducer.
- 2 – inner cover when measuring medium with strong wave motion, e.g. during rapid filling of the tank or when measuring the level in a tank with a stirrer.
- 3 – ventilation hole in the inner cover.

The ULT20 transducer continuously measures M distance. To determine the actual percentage of filling of the tank, program the transducer properly and set the points in the parameters of individual characteristics as follows:

- X1 – measured value for which we want to obtain level 0. Enter $L+M$ as the value.
- Y1 – expected value for X1 – enter value 0.

- X2 – value for which we want to obtain level 100 %. Enter *NM* as the value. Also *M* value may be entered with proper filling (*Y2*) assigned to it.
- Y2 – value to be indicated for X2 value. It will be the value of 100 % for X2 determined by *NM* or proper filling value if X2 has been defined by *M* value.

The 1/6D transducer mounting distance shown in the figure indicates the recommended mounting method for the transducer on the tank. It is not advisable to mount the transducer in the tank axis.

When measuring the flow in open channels, venturi (baffles) with a triangular cut-out are often used. An example of such an application is shown in Figure 6.

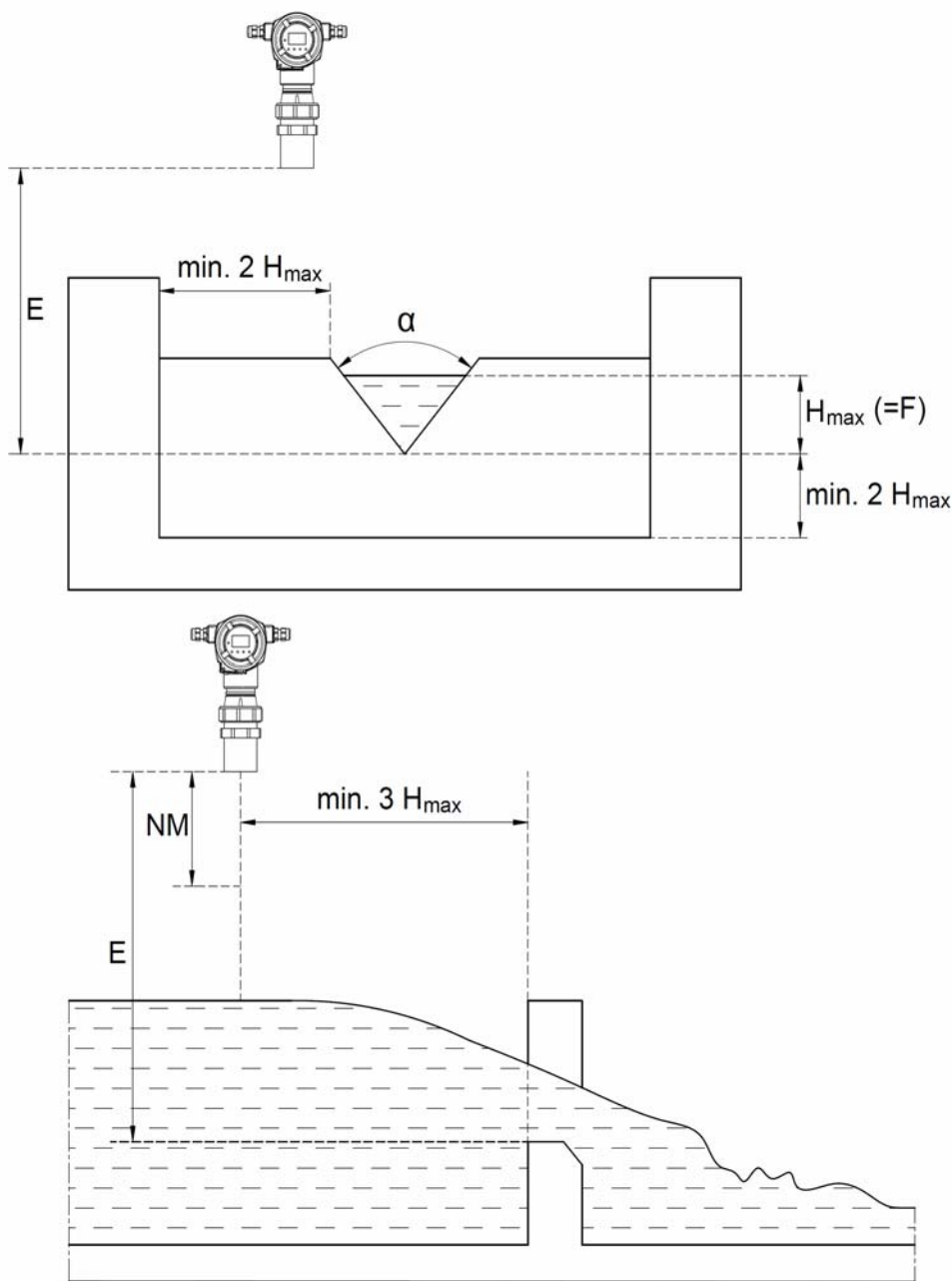

Fig. 6: Example of flow measurement in an open channel.

Markings in the drawing:

- E - measured value when there is no flow (minimum distance from the sensor for which the tide is zero).
- F - distance for nominal flow.

For specific values E and F and on the basis of the characteristics of the venturi used, it is possible to introduce an individual characteristic that converts the indication into a flow value.

5 Operation

ULT20 transducer is equipped with buttons and an LCD display, which for ease of use are placed on the front panel. After powering on the LCD displays Welcome Screen with diagnostic messages, software version and serial number. In the case of irregularities or damage to any of the components the boot process is stopped, and the display shows an error message. In this case, the User may need to press the accept button.

5.1 Description of front panel

View of the front panel ULT20 transducer, after removing the protective ring, is shown in Fig. 7. LCD display and four buttons, which together make the User interface, are placed on the front panel. Additionally, the panel is equipped with USB port for connecting the transducer to a computer for configuration, reading the archives, or preview of currently measured and calculated values.

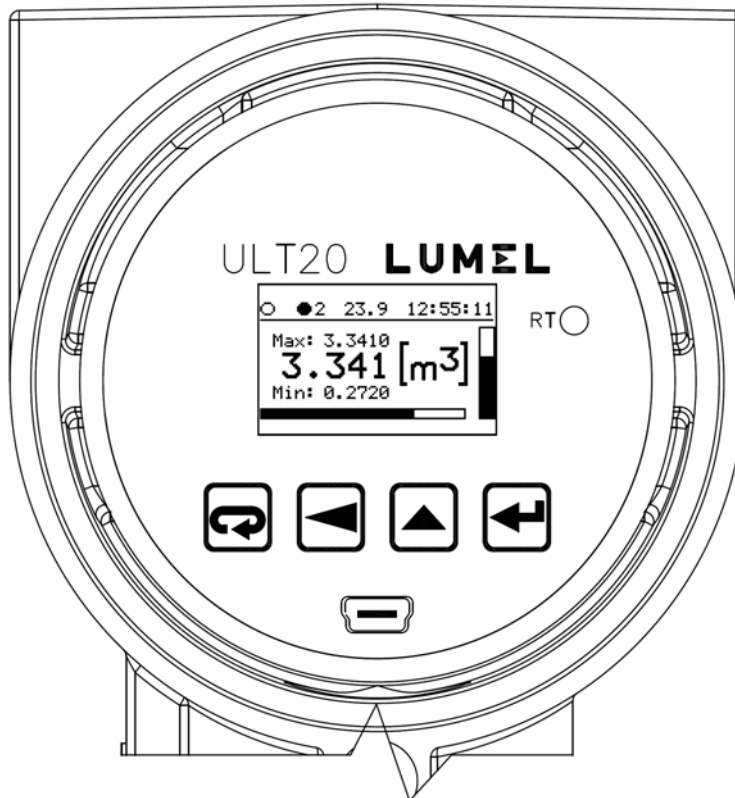







Fig. 7: Front panel.

RT diode, which is placed on the front panel, changes its state after each update of values read from the measuring head module.

5.2 Functions of buttons

	<p>Cancel button:</p> <ul style="list-style-type: none"> • Leaving the menu and exit to the main screen. • Leaving the lower level of the menu and return to the higher level. • No change to the set value (when editing a parameter value)
	<p>Button to change digits:</p> <ul style="list-style-type: none"> • Changing the displayed value - switching between main screens. • Navigating the menu - decrease the position of the menu. • Reducing the adjusted valued during parameter editing and selection of adjustable variable from the list of settings, e.g. the type of alarm. • Change of adjustable digit while setting numerical parameters.

	<p>Value increase button:</p> <ul style="list-style-type: none"> • Changing the displayed value - switching between main screens. • Navigating the menu - increase the position of the menu. • Increase the value of a selected parameter or increase the of a digit during the change of numerical value.
	<p>Enter button:</p> <ul style="list-style-type: none"> • Entering the programming mode (hold this button for minimum 3 seconds) • Navigating the menu – entering the parameter value edit mode or entering the selected lower level menu. • Accepting the changed parameter value
	<p>Deleting the memory of alarm no. 1 (hold down the buttons for minimum 3 seconds).</p>
	<p>Deleting the memory of alarm no. 2 (hold down the buttons for minimum 3 seconds).</p>
	<p>Deleting the minimum, maximum value of the transducer (hold down the buttons for minimum 3 seconds). Value or values which will be deleted depend on the displayed parameter (the current main screen), e.g. the counter is reset only when the User pushes a combination of buttons on the screen where the counter values are displayed. If the transducer menu is password-protected, then before using a combination of buttons, the User will be prompted for a password.</p>

All events related to deleting saved minimum, maximum value, memory of alarm activation and the counter status are indicated by ULT20 transducer by displaying an appropriate message, example is given in Fig. 8.







Rys. 8: Example of a message confirming deleting the selected parameter.

5.3 Transducer parameters programming

Programming the transducer parameters is possible via RS485 interface, USB interface and through direct programming with buttons and LCD display.

The direct programming process is facilitated by the transducer menu which contains the settings grouped in groups containing all the parameters related to the given functionality of the transducer, e.g. all parameters of serial interface are grouped in RS-485.menu.

Switching to the transducer menu is done by pressing the Enter button for at least 3 seconds . In case the parameters change is password protected, the User will be prompted for a password before entering the menu. Entering a wrong password allows the User to enter the menu but the change of parameters is locked - the mode of parameters browsing. Entering the correct password will move the User to the programming matrix.

Navigating around the programming matrix is done by using  . After selecting a group of parameters whose configuration is to be changed, press the Enter button to move to the parameters of the group. The selection of the parameter whose value is to be modified is done in the same way as the group selection. In case of the resignation of the parameter change, the User can leave the parameter or a group of parameters change mode by pressing the Cancel button . If during programming no button is pressed for the time of 30 seconds, the transducer automatically leaves the programming mode and returns to the last screen. The programming matrix is shown below.



ME-ASU-RE	AvgTime Time of measurement averaging. The length of moving window	Pulse K Defines the value of the transducer change to which the binary output pulse should correspond.								
PAR1	Unit Unit for value no. 1.	Over Lo Minimum value. Below this. Value lower overrun	Over Hi Maximum value. Above this value Upper overrun	DecimalP decimal point position. Resolution	Ind.Char Enable or disable individual characteristic	Point No number of points of individual characteristic	X1 Measured value -point 1.	Y1 Expected value for value X1.	X2 Measured value - point 2	Y2 Expected value for value X2.
	X3 Measured value -point 3.	Y3 Expected value for value X3.	X32 Measured value -point 32.	Y32 Expected value for value X32.				

PAR2	Unit Unit for value no. 1	Over Lo Minimum value. Below this value lower overrun	Over Hi Maximum value. Above this value upper overrun	DecimalP position of decimal point. Resolution	Ind.Char Enable or disable individual characteristic	Point No number of points of individual characteristic	X1 Measured value -point 1.	Y1 Expected value for value X1.	X2 Measured value -point 2	Y2 Expected value for value X2.
	X3 Measured value -point 3.	Y3 Expected value for value X3.	X32 Measured value -point 32.	Y32 Expected value for value X32.				
ALARM 1	Param.AI Alarm control value	Type AI Type of alarm.	OverLo AI Lower threshold of alarm state change.	OverHi AI Upper threshold of alarm state change	DlyOn.AI Delay of alarm activation	DlyOff.AI Delay of alarm deactivation	Sg.Keep.AI Alarm activity memory			
ALARM 2	Param.AI Alarm control value	Type AI Type of alarm.	OverLo AI Lower threshold of alarm state change.	OverHi AI Upper threshold of alarm state change	DlyOn.AI Delay of alarm activation	DlyOff.AI Delay of alarm deactivation	Sg.Keep.AI Alarm activity memory			
An.O-UT	Param.An Control value of analog output	Type An Type of analog output.	AnIn Lo Control Value specifying minimum value at analog output	AnIn Hi Control Value specifying maximum value at analog output	AnManVal Value of analog output current for manual operation.					
RS-485	Address Address of the transducer on the network	ModeUnit Type of transmission frame	BaudRate Baud rate of transmission							
SYSTEM	Time Current time acc. to internal clock.	Date Current date acc. to internal clock.	AutoTime Automatic day saving time.	LcdBright Brightness of LCD backlight	LcdContr. Contrast of display.	LcdStyle Style of display.	Language Language of menu and messages	V1minRst Delete minimum acc. to PAR1	V1maxRst Delete maximum acc. to PAR1	V2minRst Delete minimum acc. to PAR2.
	V2maxRst Delete maximum acc. to PAR2.	TminReset Delete minimum value of temperature	TmaxReset Delete maximum value of temperature.	CntReset Delete (reset) value of counter.	Password Password to parameters value change	Def.Par Restore factory settings.	EventDel Delete event archive.	DataDel Delete data archive.	Firm.Ver transducer software version.	SerialNo transducer serial number.

ARCH. 1	ArchVal Variable whose value is to be recorded	TrigVal Variable whose value triggers recording process.	ArchType Type of archiving - triggering	Period Frequency of data recording	DlyOn.A r Delay of recording activation	DlyOff.A r Delay of recording deactivation.	Trig.Lo Low value to change the state of recording triggering	Trig.Hi Upper value to change the state of recording triggering		
ARCH. 2	ArchVal as for ARCH.1	TrigVal as for ARCH.1	ArchType as for ARCH.1	Period as for ARCH.1	DlyOn.A r as for ARCH.1	DlyOff.A r as for ARCH.1	Trig.Lo as for ARCH.1	Trig.Hi as for ARCH.1		
ARCH. 3	ArchVal as for ARCH.1	TrigVal as for ARCH.1	ArchType as for ARCH.1	Period as for ARCH.1	DlyOn.A r as for ARCH.1	DlyOff.A r as for ARCH.1	Trig.Lo as for ARCH.1	Trig.Hi as for ARCH.1		
ARCH. 4	ArchVal as for ARCH.1	TrigVal as for ARCH.1	ArchType as for ARCH.1	Period as for ARCH.1	DlyOn.A r as for ARCH.1	DlyOff.A r as for ARCH.1	Trig.Lo as for ARCH.1	Trig.Hi as for ARCH.1		
ARCH. 5	ArchVal as for ARCH.1	TrigVal as for ARCH.1	ArchType as for ARCH.1	Period as for ARCH.1	DlyOn.A r as for ARCH.1	DlyOff.A r as for ARCH.1	Trig.Lo as for ARCH.1	Trig.Hi as for ARCH.1		





Fig. 9. Programming matrix.

5.3.1 Changing value of selected parameter

To increase the value of the selected parameter, press button . Pressing the button increases the currently set digit by 1, but after 9, is reached, pressing the button sets the value to 0. After setting the desired digit value, the User should go to the next digit by pressing the button . After setting the desired parameter press Enter button  to leave the parameter change menu and return to the previous parameter. Changing the sign of the input value is possible when setting the last digit (most significant).

Changing floating point values is done in two steps. The first step is to set digits and the sign in accordance with the above-described algorithm. The second step, which starts after Enter button is pressed, is setting the decimal point position. After setting the decimal point to the desired position, press the Enter button.

When an incorrect parameter value is entered, the new value is not accepted and the parameter automatically returns to the previous value.

Change of parameters other than numerical ones is done by selecting desired setting from the parameters list using buttons  . After selecting the desired settings, press Enter button  to load the setting or Cancel button  to return to the previous value and to leave the parameter change mode.

5.3.2 Programmable transducer parameters

ULT20 transducers have a number of programmable parameters which are listed in the tables below.

Table 1

Measure		
Symbol of parameter	Description	Scope of changes
AvgTime	Measurement time expressed in seconds – this is the averaging time of the measurement result understood as the length of the moving window	0...3600 seconds. Entering value of 0 will refresh the measurement result with maximum speed of up to about 10 measurements per second.
Pulse K	Weight of pulse of binary output – determines the change of counter which will generate 1 pulse at binary output.	0...999999

Table 2

PAR1 and PAR2			
Symbol of parameter	Description	Scope of changes	
Unit	Unit displayed next to the measured value	none	
		m	
		l	
		m ³	
		T	
		%	
		l/s	
		l/min	
		l/h	
		kg/h	
		m ³ /h	
T/h			
Over Lo	Lower overrun – measured value below which lower overrun is reported.	-99999...999999	
Over Hi	Upper overrun – measured value above which upper overrun is reported.	-99999...999999	
DecimalP	Decimal point - displaying precision. Determines the number of decimal places.	Value	Description
		000000	No decimal places
		0000.0	One decimal place
		000.00	Two decimal places
		00.000	Three decimal places

		0.0000	Four decimal places
		AUTO	Automatic format. Resolution is adjusted to the displayed value in a way ensuring the best possible precision.
Ind.Char	Individual characteristic – enable or disable the recalculation of the measured value by the entered individual characteristic.	Value	Description
		Disabled	Individual characteristic disabled
		Enabled	Individual characteristic enabled
Point No	Number of points of Individual characteristic	2...32	
Xn*	Point of individual characteristic – measured value	-99999...999999	
Yn*	Point of individual characteristic – expected value for Xn measured valued.	-99999...999999	

*n – point number of individual characteristic from 1 to 32. The number of displayed points depends on the set number of characteristic.

Table 3

ALARM 1 and ALARM 2			
Symbol of parameter	Description	Scope of changes	
Param.AI	Value which controls the alarm operation.	Value	Control value (monitored)
		ValL	Measured value without scaling
		ValInd1	Measured distance after scaling acc. to individual characteristic no. 1 (PAR1).
		ValInd2	Measured distance after scaling acc. to individual characteristic no. 2 (PAR2) – additional value.
		Temp	Temperature value measured by measuring head – temperature compensation.
		Time	Current time
		Counter	Counter value
Type AI	Alarm type – type of alarm contacts change (see p. 5.7).	Value	Alarm type
		n-on	Normally enabled
		n-off	Normally disabled
		on	Enabled
		off	Disabled
		hon	Enabled - manual control.
hoff	Disabled - manual control.		
OverLo AI	Lower threshold (control value) of the change of the alarm contacts state.	-99999...999999	
OverHi AI	Upper threshold (control value) of the change of the alarm contacts state.	-99999...999999	
DlyOn.AI	Delay of alarm contacts activation after alarm event occurrence, expressed in seconds.	0...900	

DlyOff.AI	Delay of alarm contacts deactivation after alarm event occurrence, expressed in seconds.	0...900	
Sg.Keep.AI	Backup of alarm signal - alarm memory. When this function is enabled, the event occurrence is remembered until it is reset by operator.	Value	Description
		Disabled	Alarm memory is disabled.
		Enabled	Alarm memory is enabled.

Table 4

An.OUT Analog output			
Symbol of parameter	Description	Scope of changes	
Param.An	Value which controls the analog output signal.	Value	Control value (monitored)
		ValL	Measured value without scaling
		ValInd1	Measured distance after scaling acc. to individual characteristic no. 1 (PAR1).
		ValInd2	Measured distance after scaling acc. to individual characteristic no. 2 (PAR2) – additional value.
		Temp	Temperature value measured by measuring head – temperature compensation.
		Time	Current time
		Counter	Counter value
Type An	Type of analog output – the mode of analog output operation.	Value	Mode of analog output operation.
		Off	Output disabled.
		4..20mA	Output in 4...20 mA standard
		0..20mA	Output in 0...20 mA standard
		Manual	Manual operation. Value of output current corresponds the value set in AnManVal field
AnIn Lo	Control value for which output signal should correspond the minimum value of signal for the particular type of output.	-99999...999999	
AnIn Hi	Control value for which output signal should correspond the maximum value of signal for the particular type of output.	-99999...999999	
AnManVal	Value of output current expressed in mA during manual operation mode of the output.	0...24	

Table 5

RS-485			
Symbol of parameter	Description	Scope of changes	
Adres	Address of the transducer in network	1...247	
ModeUnit	Type of data transmission frame.	Value	Description
		r8n1	Eight bits of data, no parity checking, one stop bit
		r8n2	Eight bits of data, no parity checking, two stop bits
		r8o1	Eight bits of data, parity checking, (odd parity) one stop bit
		r8e1	Eight bits of data, parity checking, (parity) one stop bit
BaudeRate	Rate of transmission expressed in b/s.	9600	
		14400	
		19200	
		28800	
		38400	
		57600	
		115200	

Table 6

SYSTEM			
Symbol of parameter	Description	Scope of changes	
Time	Current time according to internal clock	00:00:00...23:59:59	
Data	Current date according to internal clock shown as YY-MM-DD, where: YY – current year, MM – current month, DD – current day.	00-01-01...99-12-31	
AutoTime	Automatic day saving time	Value	Description
		Enabled	Function disabled.
		Disabled	Automatic day saving time enabled.
LcdBright	Brightness of LCD display backlight expressed as percentage of maximum brightness.	0...100	
LcdContr.	Contrast of LCD display.	0...63	
LcdStyle	Style of LCD display/operation.	Value	Description
		Normal	Normal display – black characters on white background

		OlInversion	Color inversion - white characters on black background
Language	Language of menu and messages.	Value	Language
		English	English
		Polski	Polish
V1minRst	Delete minimum value for the value according to PAR1.	Value	Description
		No	No action
		Yes	Skasuj wartość minimum.
V1maxRst	Delete maximum value for the value according to PAR1.	Value	Description
		No	No action
		Yes	Delete maximum values.
V2minRst	Delete minimum value for the value according to PAR2. .	Value	Description
		No	No action
		Yes	Delete minimum values.
V2maxRst	Delete maximum value for the value according to PAR2.	Value	Description
		No	No action
		Yes	Delete maximum values.
TminReset	Delete minimum value for temperature measurement	Value	Description
		No	No action
		Yes	Delete minimum values.
TmaxReset	Delete maximum value for temperature measurement.	Value	Description
		No	No action
		Yes	Delete minimum values.
CntReset	Reset the flow counter.	Value	Description
		No	No action
		Yes	Reset the counter
Password	Password to the transducer parameters change.	0...9999 For value of 0 password protection is disabled.	
Def.Par	Restore factory settings.	Value	Description
		No	No action
		Yes	Restores default (factory) settings.
EventDel	Delete events archive.	Value	Description
		No	No action
		Yes	Delete events archive.
DataDel	Delete data archive.	Value	Description
		No	No action
		Yes	Delete data archive.
Firm.Ver	Software version of the transducer.	Read-only value	
SerialNo	Serial number of the transducer.	Read-only value	

Table 7

ARCH. 1, ARCH. 2, ARCH. 3, ARCH. 4 and ARCH. 5			
Symbol of parameter	Description	Scope of changes	
ArchVal	Value to be archived.	Value	Archived value
		ValL	Measured value without scaling
		ValInd1	Measured distance after scaling acc. to individual characteristic no. 1 (PAR1).
		ValInd2	Measured distance after scaling acc. to individual characteristic no. 2 (PAR2) – additional value.
		Temp	Temperature value measured by measuring head – temperature compensation.
		Counter	Counter value
TrigVal	Value which controls the recording triggering process.	Value	Archived value
		ValL	Measured value without scaling
		ValInd1	Measured distance after scaling acc. to individual characteristic no. 1 (PAR1).
		ValInd2	Measured distance after scaling acc. to individual characteristic no. 2 (PAR2) – additional value.
		Temp	Temperature value measured by measuring head – temperature compensation.
		Time	Current time
		Counter	Counter value
ArchType	Type of archiving – way the archiving is triggered. Archiving is triggered in the same way as alarms are triggered (see p. 5.4.4). With this parameter, the User can determine the relationship between TrigVal and the thresholds of Trig.Lo and Trig.Hi to identify the triggering condition of recording.	Value	Archived value
		n-on	Normally enabled
		n-off	Normally disabled
		on	Enabled
		off	Disabled
		hon	Permanently enabled - manual control.
		hoff	Permanently disabled - manual control.
Period	Period of archiving - frequency of archived value recording expressed in seconds. This parameter determines time interval between subsequent archived measurements.	1...3600	
DlyOn.Ar	Delay of archiving enabling – time in seconds from the moment when archiving is triggered to the moment when data recording starts.	0...900	

DlyOff.Ar	Delay of archiving disabling – time in seconds from the moment when archiving triggering is completed to the moment when data recording stops.	0...900
Trig.Lo	Lower threshold (control value) at which data recording triggering status changes.	-99999...999999
Trig.Hi	Upper threshold (control value) at which data recording triggering status changes.	-99999...999999

5.4 Functions of the transducer

5.4.1 Distance measurement

ULT20 transducers are designed to measure and convert the measured distance between the transducer and the obstruction which reflects ultrasonic waves into standard analog signal. In addition, the measurements can be read from the transducer via the RS-485 interface. The maximum measuring range is 8 m, bearing in mind that it is highly dependent on the material that obstacles to the waves are made of. When installing the transducer, it should be ensured that it is situated perpendicular to the obstacle to which the distance is to be measured.

Distance measurement is done using ultrasonic waves, whose velocity is strongly dependent on the medium in which the waves propagate. The measuring head is equipped with a temperature sensor which compensates for the effect of temperature on the measurement accuracy. Note, however, that during measurement the waves move in the medium, which at each stage of the measurement may be characterized by varying parameters in relation to where the measuring head is placed (e.g. high value of temperature gradient). Also note that some of the measured objects, besides reflecting ultrasonic waves, are also characterized by a high absorption of waves which penetrate into the measured substance which can significantly affect the measurement range.

The dead zone of the transducer is about 0.3 m. If the obstacle is located at a distance of less than 0.3 m, the measuring unit is set in measurement standby mode which is displayed on the screen with the symbol „----”.

The measurement value can also be limited by the User when the minimum and maximum measured values are specified. Exceeding the set lower threshold of the measurement (measured value is smaller than the set limit value) results in displaying information about lower overrun, and when the measurement exceeds the set upper threshold of the measurement range (measured value is bigger than the set limit value) the screen displays information about upper overrun. The threshold values of the measurement range are set separately for each of the individual characteristics, and the configuration of the range thresholds can be accessed from the transducer menu, respectively *PAR1* for the first individual characteristic and *PAR2* for the second individual characteristic.

5.4.1.1 Measured value averaging

The measured distance value may be averaged at a specified time. Algorithm of moving window is used during measurement result averaging. After averaging is turned on (the setting of averaging time is greater than zero) the measured value determines the average value of the set time, e.g. for the averaging time of 60 seconds the indicated value determines the measured value averaged during the last 60 seconds, and the update of the measured value is done with the interval of 1 second and in each case represents the average value of the set period.

If the averaging algorithm is turned off (the averaging time is set to zero), the measured value is refreshed 10 times per second. Each refresh of the measured value is indicated by a change in the RxTx LED located on the front panel.

5.4.1.2 Minimum and maximum measured values

ULT20 transducer continuously measures the distance. If the measurement range is not exceeded during measurement (the physical one resulting from the parameters of the measuring head or the logical one resulting from the limitation of the measurement range set by the User), the minimum and maximum values for each measurement recalculated by the individual characteristics according to parameters PAR1 and PAR2 are continuously recorded. In addition to the recorded minimum and maximum value, the date and time of its occurrence is assigned to each value.

The minimum and maximum values are displayed when the measured value is displayed, where the minimum value (Min) is displayed below the measured value, and the maximum value (Max) is displayed above the measured value. In addition, the transducer offers dedicated screens with minimum and maximum values for the main measured value (recalculated according to the PAR1) which also display the date and time of the value occurrence.

Deleting the minimum and maximum value is possible from the keyboard by pressing and holding the combination of button ◀ ▶ or via the communication interface. It should be noted that deleting from the keyboard only works when the screens with the following values are displayed: the minimum and maximum value or the value recalculated according to PAR2. If the counter value is displayed, then the content of the counter is reset to zero.

Deleting the minimum and maximum value is done by entering the currently measured value into the value which is to be canceled. Minimum and maximum values are stored after a power failure.

5.4.1.3 Individual characteristics

The measured value can be recalculated by the entered individual characteristic, and the transducer is equipped with two implemented independent individual characteristics allowing for any recalculation of the indicated distance. All additional functions such as alarms, analog output and archiving can be triggered by the measured value which is not recalculated or recalculated according to selected individual characteristic. The number of points and the values describing the characteristics points are defined in *PAR1* parameter group for the first individual characteristic and *PAR2* for the second individual characteristic. Configuration of parameters of characteristics can also be done through the communication interface.

The User can determine the number of points of characteristic (up to 32 points) and define them. However, the User should remember that during programming the subsequent introduced points must meet the following correlation:

$$X1 < X2 < X3 < \dots Xn,$$

where Xn - the last point of characteristic.

Failure to meet this correlation will result in disabling the individual characteristic and setting an error flag in the register of the transduce status.

A graphical interpretation of the individual characteristic function is shown in the example shown in Fig. 10.

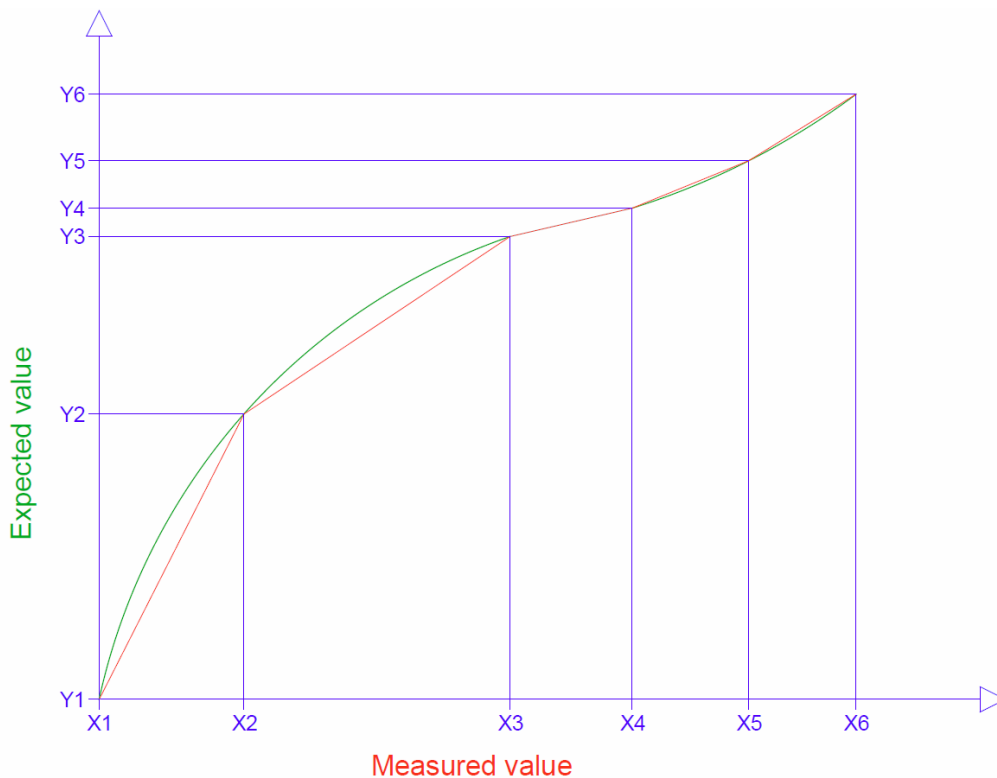

Fig. 10. Individual characteristic.



In order to define the points of the individual characteristic the points of characteristic are determined by specifying X and Y values for each point. The value X of a point is the distance measurement value, and the Y value determines the desired value of measurement for X value measurement.

During approximation of functions which strongly deviate from linear function it should be remembered that the greater is the number of introduced points the smaller is the error of the function linearization.

For measured values smaller than the X1 the value is recalculated according to the first linear function determined on the basis of points (X1, Y1) and (X2, Y2). Similarly, for the measured values greater than the last entered point the recalculation is done according to the last determined function.

5.4.1.4 Counter

The transducer has a built-in counter function which is used to measure (count) the flow in open channels where the flow function can be described by the height of the measured column of the flowing liquid. Based on the recalculation of height into flow we receive an indication in the unit of flow per hour. On the basis of the count of momentary values per time unit and their summation the indication of the counter is obtained.

The content of the counter is displayed on the Counter page, where the value can also be reset by pressing the buttons   simultaneously.

The transducer is equipped with binary pulse output, which generates one pulse during counting a pulse with proper programmable weight. The content of the transducer is stored after a power failure.

5.4.2 Analog output

ULT20 transducers are equipped with analog current output whose terminals are located available on the terminal block JE2 (signals An.OUT). The analog output can be used for the processing of the measured value into a standard current signal 4 ... 20 mA or 0 ... 20 mA. The value (mapped) which controls the analog output is set at the stage of the output configuration (*An.OUT* menu) and it can be:

- The value of the measured distance without rescaling.
- The value of the measured distance after rescaling according to the first individual characteristic.
- The value of the measured distance after rescaling according to the second individual characteristic.
- Temperature - the temperature value measured by the measuring head.
- Time - the current time.

- Counter - the content of the counter.

The choice of the control value does not matter if the output mode (*Type An*) was set as *Off* or *Manual*, in the latter case, the value of the output signal is set manually (setting *AnManVal*). This mode is mainly intended for the diagnostics of correct operation of the measuring system and to control the operation of the analog output.

In addition to these settings there are also two settings of the output type:

- 4..20 mA - the output works in 4-20mA standard, with 4 mA signal corresponding to the measured value determined by *AnIn Lo.* setting. Whereas 20 mA signal corresponds to the measured value determined by *AnIn Hi.* setting.
- 0..20 mA - the output works the same way as for setting 4..20 mA, whereas the measured value equal to *AnIn Lo* setting corresponds the output signal of 0 mA.

The above mentioned settings allow the introduction of additional individual characteristic for the analog output.

Note: In the case where the control value of the analog output is derived from the output if individual characteristic, it should be noted that changing the individual characteristic affects the operation of the analog output.

In case of **loss of echo (measurement error)**, the analog output signal corresponds to the set value of current in the setting *AnManVal*.

5.4.3 Binary pulse output

Binary pulse output works with the flow transducer. Configuration of counter operation is done from *Measure* menu, where the User must set the pulse weight, which is the value of the counter change corresponding to generating a single pulse. For example, for setting of 0.01 each change of the counter by a preset value will result in a pulse generated at the binary output. When the counter counts the value of 1, it correspond to the generation of 100 pulses.

The binary output is terminated at the external terminals of connector JE1 marked as *BIN OUT*. Example of binary output connection with any counter is shown in Fig. 11.

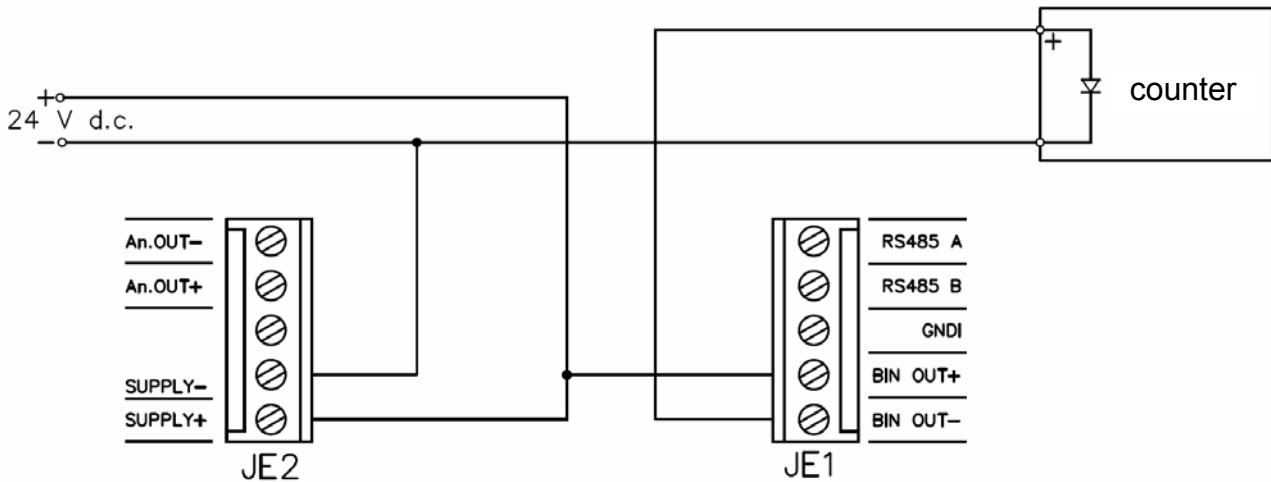

Fig. 11. Example of binary output connection.

Pulse on binary output lasts 30 ms. The time between pulses depends on the rate of counts, but it is not less than 30 ms.

5.4.4 Alarm outputs

ULT20 transducer is equipped with two alarm outputs with NO contact, which are routed to the terminal block of external connections - J3.

Note: Alarm outputs are based on semiconductor relays. Disabling the output does not physically break the circuit. When using the outputs do not exceed the permissible operating current and voltage.

Each alarm can be configured to operate in one of six modes. For each alarm, the User can select the alarm operation control value and set thresholds of the alarm status changes. Fig. 11 shows how the alarms work in the following modes *n-on*, *n-off*, *off* and *on*. In addition, there are manual modes *h-on* and *h-off*, which allow respectively for switching on or off the alarm permanently.

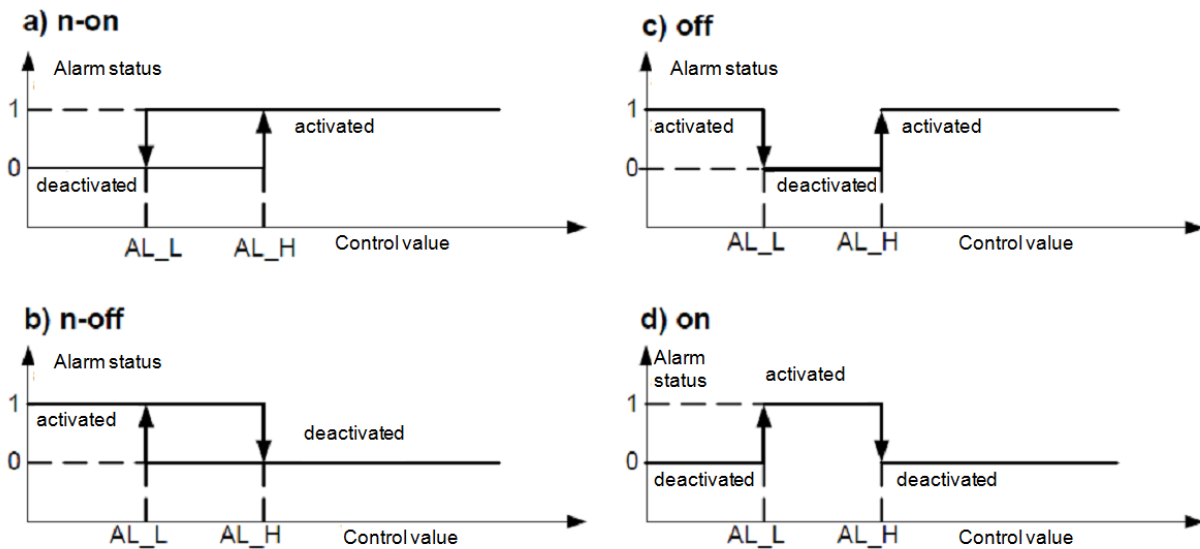

Fig. 12. Alarm types: a) n-on; b) n-off; c) on; f) off.

AL_L – Lower threshold of alarm (OverLo AI) – lower value of the relay contacts state change

AL_P – Upper threshold of alarm (OverHi AI) – upper value of the relay contacts state change.

Note: During alarm configuration, be sure to put the threshold values which meet the correlation $AL_L < AL_P$. Failure to meet this correlation will disable alarms. In the case of damage to the measuring head (no communication with the head) the process of re-initializing of the head begins where the alarms state remains in the previous position.

In addition, alarm functions have been equipped with programmable delay of the alarm activation and deactivation. The User can specify how long the minimum time of duration of an alarm event before the alarm relay contacts are triggered and the minimum time of the alarm event decay before the relay contacts are activated.

Alarm activation can be remembered if the memory function is enabled.

5.4.5 LCD display

ULT20 transducers are equipped with backlit graphic LCD display with adjustable brightness of backlight and adjustable contrast. The display resolution is 128 x 64 points. Measured and calculated parameters are displayed on the defined screens. Upper status bar is displayed on each screen which shows the status of the alarm, the measuring head temperature and the current time. Views of sample screens are shown in the figures below. In addition, the screen with measured values contains bar graphs which graphically

show the measured instantaneous value (vertical bar graph) and level of analog output signal (horizontal bar graph).

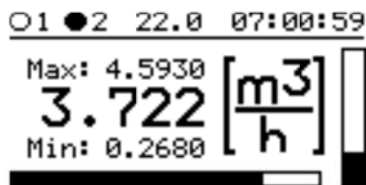

Fig. 13. View of the main screen.

The main screen shown in Fig. 13 is made up of elements that represent the state of the device and the measured value:

- The top status bar with information about the status of alarms, the temperature of measuring head and the current time. When the time indicator is flashing, it means that the time must be set.

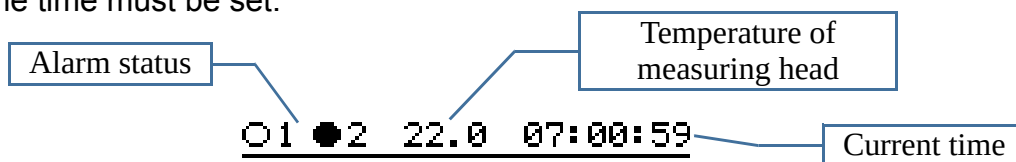

Fig. 14. View of the main screen.

- *Max* – recorded maximum value of measured variable.
- Current measured value after scaling with individual characteristic according to PAR1 and averaged in the set time window.
- *Min* - recorded minimum value of measured variable.
- Horizontal bar graph - the degree of analog output vu.
- Vertical bar graph - instantaneous value of the measured variable.

Symbols related to alarms displayed on the screen are shown below:

Symbol	Description
O1	Alarm no. 1 in inactive state (relay contacts open). Flashing symbol means the alarm signal memory - memory of activation.
●2	Alarm no. 2 in active state (relay contacts closed).

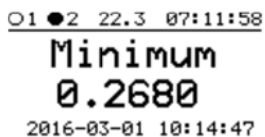

Fig. 15. Displaying of minimum value.

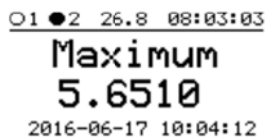

Fig. 16. Displaying of maximum value.

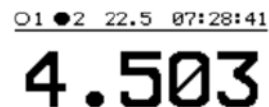

Fig. 17. Measured value according to PAR1.

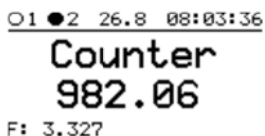

Fig. 18. Content of the counter with the main measured value.

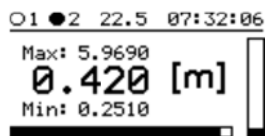

Fig. 19. Measured value recalculated acc. to PAR2.

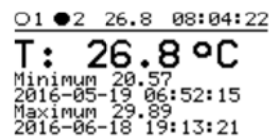

Fig. 20. Temperature of head with minimum and maximum value

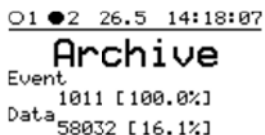



Fig. 21. Summary of archive – number of records and level of memory usage.

Switching between successive screens is done using the buttons placed on the front panel. Pressing the button  takes you to the next screen. While pressing the button  takes you to the previous screen.

During operation, the screen may display information screens, which can be divided into two groups:

- Screens confirming the command completion - e.g. screen confirming screen deletes the alarm memory.
- Screens with error messages. Screen with an error message is displayed until the error is resolved. Possible error messages and their meanings are listed in Section 6.

5.5 Factory settings

ULT20 transducer is supplied with the initial default configuration, which can be restored from the transducer menu after selecting *MENU*→*SYSTEM*→*Def.Par* and set it to Yes which will restore the default settings. When factory settings are restored the recorded minimum, maximum values, the contents of the counter, the recorded archived values and the time and date do not change.

Note: Restoring the default settings will change the menu language into English.

The default settings are shown in Table 8.

Table 8

Menu level	Setting	Standard value
MEASURE	AvgTime	0
	Pulse K	1.0000
PAR1, PAR2	Unit	[m]
	Over Lo	-99999
	Over Hi	999999
	DecimalP	00.000
	Ind.Char	Disabled
	Point No	2
	X1	1
	Y1	1
	X2	2
	Y2	2

ALARM 1, ALARM 2	Param.AI	ValInd1
	Type AI	h-off
	OverLo AI	1.0000
	OverHi AI	3.0000
	DlyOn.AI	0
	DlyOff.AI	0
	Sg.Keep.AI	Disabled
An.OUT	Param.An	ValInd1
	Type An	4..20mA
	AnIn Lo	0
	AnIn Hi	5
	AnManVal	0
RS-485	Address	1
	ModeUnit	r8n2
	BaudeRate	9600
SYSTEM	Time	Not applicable
	Data	Not applicable
	AutoTime	Disabled
	LcdBright	60 %
	LcdContr.	14

	LcdStyle	Normal
	Language	English
	V1minRst	No
	V1maxRst	No
	V2minRst	No
	V2maxRst	No
	TminReset	No
	TmaxReset	No
	CntReset	No
	Password	0
	Def.Par	No
	KasujArchZd.	No
	KasujArchDa.	No
	Firm.Ver	Not applicable
	SerialNo	Not applicable
ARCH. 1, ARCH. 2, ARCH. 3, ARCH. 4, ARCH. 5	ArchVal	MeasurementL
	TrigVal	MeasurementL
	ArchType	h-off
	Period	60
	DlyOn.Ar	0
	DlyOff.Ar	0
	Trig.Lo	1.0000
	Trig.Hi	3.0000

5.6 Archiving

ULT20 transducers are equipped with archive memory, which is divided into two areas:

- Events memory - memory area containing the records of system events, such as e.g. powering-on and power failure, activation and deactivation of the alarm, etc.
- Data memory - memory area containing the records of the data recorded according to the archiving configuration defined in groups of settings *ARCH.1*, *ARCH.2*, *ARCH.3*, *ARCH.4* and *ARCH.5*.

All data stored in the archive is stored in the form of records stored in the data memory in the form of pages, where each page is 528 bytes. Maximum 44 records can be stored on each page of the memory. Each record is 12 bytes. Detailed structure of a record is presented in section 5.6.1.

Event memory occupies the first 23 pages of memory and allows for recording 1011 records. The remaining memory space is designed to record data archive and allows for recording 359,436 records. Total memory of archived data consists of 8,192 pages.

Reading records from the memory is carried out using communication interface RS-485 or USB by sending the page number up to 4081 register, which we want to read, and then reading this page from the registers located in memory from the address of 5000.

The beginning and the end of the archive is defined by defining the address in memory where the data starts and defining the end of the data as the beginning of the next record to be recorded. The address of beginning or the end of the archive allows the User to easily determine the number of page and the number of the starting byte referenced by the address. The address should be simply divided by the number of records per page (44) and then divided by the size of the record (12).

Archive is placed in the memory as a circular buffer. Deleting the archive involves assigning the address of end of the archive to the beginning of the archive which in the case of the archive deletion allows for its recovery.

5.6.1 Structure of record

The archive built-in the ULT20 transducer is stored in the form of records stored in a separate archive memory. Each record consists of twelve bytes. Detailed structure of a record is presented below.

Table 9

Record of archive memory - 12 bytes								
Identification		Date			Time			Value
1 byte	1 byte	1 byte	1 byte	1 byte	1 byte	1 byte	1 byte	4 byte
Group	ID	Year	Month	Day	Hour	Minutes	Seconds	Data

The meanings of a record fields are as follows:

- **Group** – determines whether the archived variable belongs to archive data (value of 0) or to system events (value 1)
- **ID** – the ID of the recorded event. This field specifies the type of the recorded event (archiving of events). For data archiving the value of this field corresponds to the archived value setting in accordance with the following numbers:
 - ID = 0 – the value of the measured distance without rescaling.
 - ID = 1 – the value of the measured distance after rescaling according to PAR1.
 - ID = 2 – the value of the measured distance after rescaling according to PAR2.
 - ID = 3 – the value of the measured temperature of measuring head.
 - ID = 4 – the content of the counter.

In the case of system events archiving the recorded *Wartość* takes 1 for the start of the event, or 0 for the end of the event. List of archived events is presented in section 5.6.3.

- **Year** – defines the year of recording in the format YY e.g. for the year 2016 the value of 16 will be recorded.
- **Month** – defines the month of recording (from 1 to 12).
- **Day** – defines the day of recording (from 1 to 31).
- **Hour** – defines the hour of recording (from 0 to 23).
- **Minute** – defines the minute of recording (from 0 to 59).
- **Second** – defines the second of recording (from 0 to 59).
- **Data** – the value recorded in the form of the number of float type (single-precision floating-point number).

5.6.2 Measured values archiving

Archiving of measured or calculated values may be carried out continuously with a predetermined time interval, or may be triggered if specified programmed condition is met by the triggering value. In addition, a delay in the start and the end of recording is introduced in order to eliminate short-term stimuli of the recorder and to enable measurement recording a moment after the condition of recording is over.

ULT20 transducer has five fully independent archiving channels so that it is possible to configure precisely the archived parameters so that the data record is carried out, for example, only in emergency.

The following is a description of the parameters that must be configured to start the selected archiving channel:

- **ArchVal** – the setting determines the variable whose value is to be archived.
- **TrigVal** — the setting determines the variable, the value of which is to trigger archiving of the value specified in the setting *ArchVal*. This setting is irrelevant for continuous archiving (*ArchType* = h-on) or when archiving is stopped (*ArchType* = h-off).
- **ArchType** – the type of archiving as a condition that must be met by the triggering value in order to start archiving. If you select the setting h-on, the archiving takes place in a continuous manner, and for setting *h-off* the archiving is stopped. The way of triggering is the same as for the operation of alarms which is shown in Fig. 12.
- **Period** – the interval, expressed in seconds, between successive values stored in the archive. The set value determines the time between successive archived records.
- **DlyOn.Ar** – the time, expressed in seconds, during which the archiving must be active (triggering condition is met) before the start of the process of data recording into the archive. This time is counted each time after recorder is activated.

- **DlyOff.Ar** – the time, expressed in seconds, during which the recording is carried out despite the condition of recording is no longer present. This time is counted each time after the termination of recording condition, if recording was carried out (the activation of the recorder does not start the countdown by itself, the recorder must be active, that is it must be in the process of data recording).
- **Trig.Lo** – lower value of the recorder status change (activation of recorder) For the following recording modes: on, off, n-on, n- off, when the triggering value set in parameter **TrigVal** reaches this value the recorder will be activated or deactivated according to the selected type of triggering.
- **Trig.Hi** – upper value of the recorder activation change. It affects the recorder operation as for the parameter *Trig.Lo*.

5.6.3 Events archiving

The built-in archive memory is divided into two areas. The first area is event memory and the second is the storage of archived data. Event memory allows the User to record 1,011 records reflecting the occurring events. During the archiving of events the event beginning and the end is stored in case of many events. There some exceptional events that uniquely define the beginning or the end of the event, such as, for example, power supply switching on or off, which are separate events. Table 10 shows all events with detailed archiving of the beginning and the end of the event. The first column contains a numeric event ID, which is stored in the ID record field.

Table 10

ID	Event	Archiving of the beginning of the event	Archiving of the end of the event
0	Global configuration error.	YES	NO
1	transducer not calibrated – event recorded during powering-up	YES	NO
2	Damaged memory of system registers – group 1.000.	YES	NO
3	Damaged memory of system registers – group 1.500.	YES	NO
4	Damaged memory of system registers – group 2.500.	YES	NO
5	Damaged memory of registers starting with address 4000.	YES	NO
6	Damaged memory of registers starting with address 7800.	YES	NO
7	Error of communication with configuration memory.	YES	YES
8	Error of communication with archive memory.	YES	YES
9	Error of communication with analog output module.	YES	YES
10	Real-time clock is not set.	YES	YES
11	Error of communication with sensor module (measuring head).	YES	YES
12	Loss of minimum value according to PAR1.	YES	NO
13	Loss of maximum value according to PAR1.	YES	NO

14	Loss of minimum temperature of the head.	YES	NO
15	Loss of maximum temperature of the head.	YES	NO
16	Loss of minimum value according to PAR2.	YES	NO
17	Loss of maximum value according to PAR2.	YES	NO
18	Loss of process data (counter, number of pulses to be generated at binary output, active page displayed on the LCD, data on archive filling).	YES	NO
31	Wrong configuration of analog output. Lower and upper threshold set at the same value.	YES	YES
32	Wrong configuration of individual characteristic according to PAR1.	YES	NO
33	Wrong configuration of individual characteristic according to PAR2.	YES	NO
34	Activation of AL1 alarm relay.	YES	YES
35	Activation of AL2 alarm relay.	YES	YES
36	Exceeded range at auxiliary analog output (service event).	YES	YES
37	Exceeded range of supply voltage – voltages outside the range of operation.	YES	YES
38	Supply voltage of the head outside the the range of normal operation (e.g. due to too low supply voltage).	YES	YES
39	Main supply voltage outside permissible range.	YES	YES
40	Exceeded permissible operation temperature range.	YES	YES
41	Wrong value of the voltage of battery supplying the internal real-time clock.	YES	YES
42	Switching on / return of main power supply.	YES	NO
43	Loss of main power supply.	YES	NO
44	Change of the transducer configuration.	YES	NO
45	Time change due to Day Saving Time .	YES	NO
46	Time change - manual change of time.	YES	NO
47	Minimum value according to PAR1 was deleted.	YES	NO
48	Maximum value according to PAR1 was deleted.	YES	NO
49	Minimum value according to PAR2 was deleted.	YES	NO
50	Maximum value according to PAR2 was deleted.	YES	NO
51	Minimum value of measuring head temperature was deleted.	YES	NO
52	Maximum value of measuring head temperature was deleted.	YES	NO
53	Flow counter was deleted.	YES	NO

A sample record for return of power supply on 2016.02-28 at 11:26:47 will look like

Identification		Date			Time			Value
1 byte	1 byte	1 byte	1 byte	1 byte	1 byte	1 byte	1 byte	4 bytes
Group	ID	Year	Month	Day	Hour	Minutes	Seconds	Data
1	42	16	2	28	11	26	47	1.0

5.6.4 Downloading archived data

Readout of the contents of the internal archive is possible using RS-485 or USB interface. Current parameters of the archive, the address of the beginning and the end of the data is available in the group of registers with addresses starting from the address 5000. Based on the parameters of the beginning and the end of the archive, the User can calculate the number of records in the archive.

Readout of the contents of the archive is done by calculation of the first page of memory on which the beginning of the archive can be found. When calculating the number of the page, it should be remembered that each page consists of 528 bytes, and each record is 12 bytes. Then the number of the memory page to be read should be entered into the register 4081. After saving the memory page number, the indicated page is retrieved from the memory and placed in the registers starting from the address 5009. Each record contains two bytes of the read page. The fact that the indicated page is placed in the registers starting from the address 5009 is confirmed in the register 5000, where the number of page whose data is currently located in registers starting from the address 5009 is placed. After reading the page, the User should indicate the next number of page to be read and re-download its contents from the registers with the address of 5009. Readouts must continue until the end of the archive is reached.

When the address of the end of the archive is smaller than the address of the beginning of the archive, after reaching the physical page number, which is the last page of memory, the User should start readout from the beginning of the archive, that is from the page numbered 0 for the event archive or from the page numbered 23 for the data archive.

The placement of data in the archive and direction of suggested reading is shown in Fig. 22.

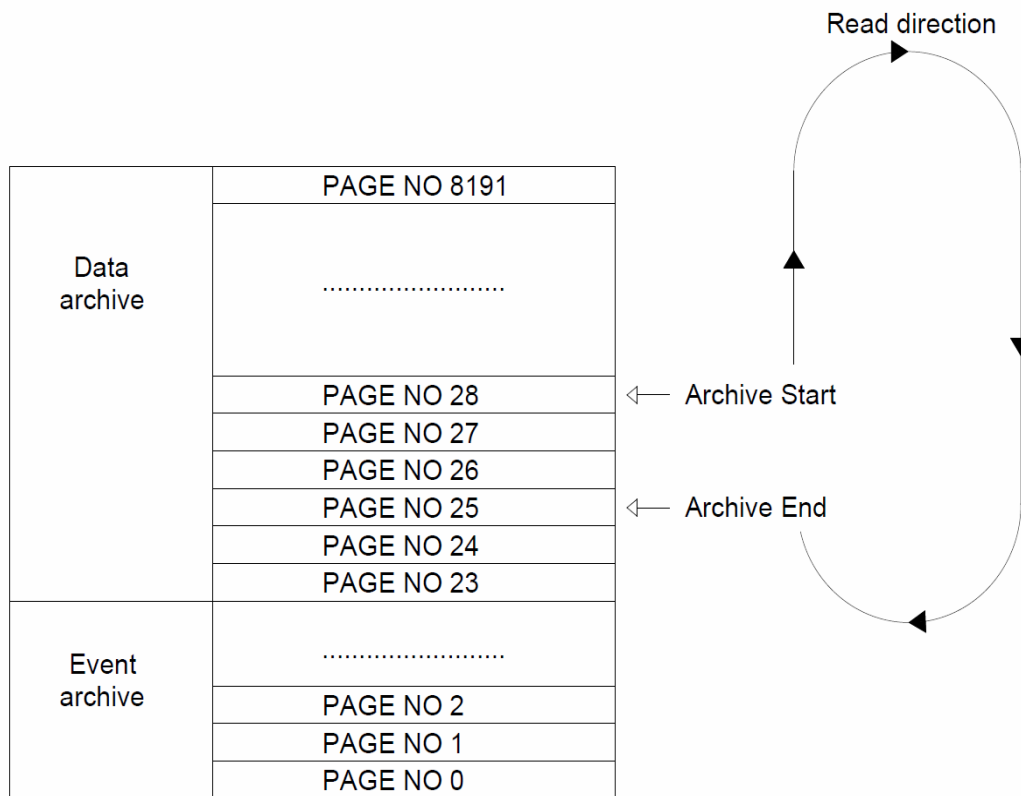

Fig. 22. Direction of archive reading.

After readout of archived data is complete, if the archive is to be deleted, it is recommended to re-check the addresses of the beginning and the end of the archive, because archiving could have taken place while reading the archive, which changed the addresses of the beginning and the end of the archive. Due to the fact that the reading of the archives is a long process, and archive format is a circular buffer where the oldest data is overwritten by the latest one, it is recommended to read the archive starting always from the address of the beginning of the archive, and after the completion of the process of reading the end of archive should be read again in order to read the latest records. Only after such reading the archive can be deleted.

Deleting archived data can be made from the level of the transducer menu or via RS485 or USB interface. To clear the event archive the value 1 should be entered into register 4048. Deleting the data archive is done by entering the value 1 into register 4049. After entering the value 1 to the aforementioned registers the transducer immediately erases the memory of events or the archive and sets the registry value at 0 as the confirmation of the command execution.

5.7 RS-485 interface

ULT20 transducers are equipped with galvanically isolated interface compliant with RS-485 standard. The implemented data exchange protocol compliant with MODBUS RTU standard, allows for recording all configuration parameters and commands to the transducer.

cer, such as, for example, archive deletion. In addition, the interface allows the User to read all the measured and calculated values. In the network the transducer is *slave* device. RS-485 standard allows direct connection to 32 devices on a single serial link. The maximum permissible cable length depends on the baud rate and for rate of 9600 b/s is 1200 m. To connect more devices or to apply greater length of connection the User should use intermediate-separating amplifiers e.g. PD51 manufactured by LUMEL S.A.

5.7.1 Connection

Connection of RS-485 interface to the ULT20 transducer is possible via terminals A, B and GNDI, whose location in the housing is shown in Fig. 4. To obtain correct transmission it is necessary to connect lines A and B in parallel with their equivalents in other devices.

Connection must be made with a shielded cable consisting of twisted wire pairs in such a way that the lines A and B make one pair and are connected with their counterparts in other devices on the network. The cable shield must be connected to protective terminal as close as possible to ULT20 transducer. To do this, the User can connect the cable shield to the protective terminal located in the housing, and the housing connect to the protective terminal located on the outside of the housing. Please note that the interface cable shield must be connected to the protective terminal at one point only.

GNDI line, which is the reference potential for RS-485 interface is used for additional protection of the interface line at long connections. In this case, all GNDI lines of all devices located on a common bus should be connected together.

When connecting the devices, avoid connections in a star configuration. The connection system should have the system bus whose ends are terminated with terminating resistors.

The way to connect devices is shown in Fig. 23.

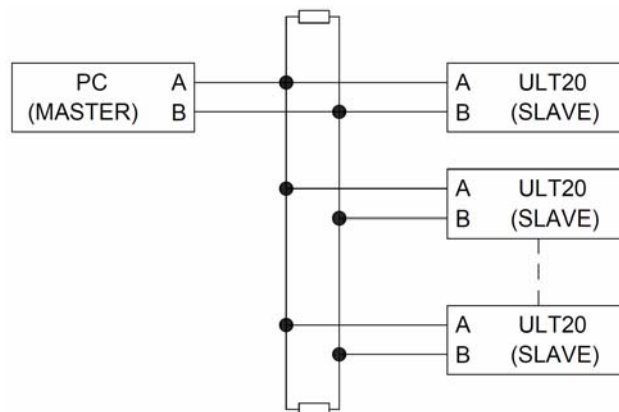

Fig. 23. The way of RS-485 interface connection.

5.7.2 Description of MODBUS protocol implementation.

The implemented protocol is in accordance with the standard PI-MBUS-300 Rev G of Modicon Company.

When configuring the connection parameters, keep in mind that devices operating on one bus must meet the following requirements:

- Have a unique address different from addresses of other devices connected to the network.
- The same data transmission speed.
- The same type of information unit (single data frame format). ULT20 transducers allow the user to program the following parameters of RS-485 link:
- The address of the transducer: 1...247.
- Transmission speed: 9600, 14400, 19200, 28800, 38400, 57600, 115200 [b/s].
- Operating mode: RTU with frame of 8n1, 8n2, 8o1, 8e1.
- Maximum time to commence the response: 50 ms.

5.7.3 Implemented functions of MODBUS protocol

The following functions of MODBUS protocol are implemented in ULT20 transducers:

- 03 (03h) - readout of register group.
- 04 (04h) - readout of input register group.
- 06 (06h) - recording of single register.
- 16 (10h) - recording of register group.
- 17 (11 h) - device identification slave.

5.7.4 Map of registers

Map of registers of ULT20 transducers is divided into areas which are separate groups of 16-bit or 32-bit registers. The data in 32-bit registers are additionally available in the form of 16-bit registers, and the value of one 32-bit register is placed in two 16-bit registers.

32-Bit registers contain data in float format compliant with IEEE-754. Order of bytes: B3 B2 B1 B0 – the oldest byte is sent first. 16-Bit registers representing 32-bit values in two subsequent registers are doubled in another address area with the following bytes order: B1 B0 B3 B2.

The table below shows the map of registers of ULT20 transducer. The addresses given in the table are logic addresses. When the User uses programs where addresses are given in logic format, the number of register should be increased by 1.

Address range	Value type	Description
4000 – 4081	16 bits	Registers for recording and reading – configuration registers
4300 – 4435	16 bits	Read-only registers with system parameters values
5000 – 5272	16 bits	Read-only registers - readout of archive parameters and archive memory pages
7500 – 7533	32 bits (float)	Read-only registers with measured and calculated values.
7800 – 7949	32 bits (float)	Registers for recording and reading – configuration data.
8000 – 8063	16 bits	Read-only registers. Registers contain the same data as registers 7500-7533, and one value is placed in two subsequent registers.
8200 - 8498	16 bits	Registers for recording and reading. Registers contain the same data as registers 7800-7940, and one value is placed in two subsequent registers.

5.7.4.1 Registers 4000 – 4081

16-bit configuration registers for recording and reading.

Ad- dress	Symbol	Acceptable values	Default	Description	
Serial port parameters					
4000		1...247	1	The device address on the Modbus network.	
4001		0...6	0	Rate of transmission expressed in [b/s]	
				Value	Description
				0	9600
				1	14400
				2	19200
				3	28800
				4	38400
				5	57600
4002		0...3	0	Type of transmission frame - data format	
				Value	Description
				0	8N1
				1	8N2
				2	8O1
				3	8E1
				4003	
Setting real-time clock (registers contain the date and time of the clock last setting)					
4004		0...99	15	Real-time clock – year – value to set the current year.	
4005		1...12	1	Real-time clock – month – value to set the current month.	

4006		1...31	1	Real-time clock – day – value to set the current day.	
4007		0...23	0	Real-time clock – hours – value to set the current value of hours.	
4008		0...59	0	Real-time clock – minutes – value to set the current value of minutes.	
4009		0...59	0	Real-time clock – seconds – value to set the current value of seconds.	
4010		0, 1	0	Apply the entered time. Entering value of 1 results in setting the clock for time and date specified in registers 4004...4009. After application of changes the register is reset.	
4011		0, 1	0	Automatic day saving time. Entering the value of 1 results in activation of automatic function of day saving time.	
LCD and display parameters					
4012		0...100	60	Brightness of LCD display backlight.	
4013		0...63	14	Contrast of LCD display.	
4014		0, 1	0	Style of displaying. Entering the value of 1 results in displaying inverted image. For the value of 0 standard displaying applies.	
4015		0...5		Resolution (precision) of main value displaying – also decimal digits	
				Value	Description
				0	No decimal places
				1	One decimal place
				2	Two decimal places
				3	Three decimal places
				4	Four decimal places
5	Automatic format. Resolution is adjusted to the displayed value in a way ensuring the best possible precision.				
4016		0...11	1	Display unit for main value displaying.	
				Value	Unit
				0	None
				1	m
				2	l
				3	m ³
				4	T
				5	%
				6	l/s
				7	l/min
				8	l/h
				9	kg/h
				10	m ³ /h
11	T/h				
4017		0, 1	0	Language of menu and messages.	
				Value	Language

				0	English
				1	Polish
4018		0...3600	0	Averaging time of moving window expressed in seconds – measurement of basic value. For the value of 0 the averaging function is disabled and measurement is done with maximum speed	
4019		0, 1	0	Restore default settings. Entering the value of 1 results in return of all settings to default and register reset.	
4020		0...9999	0	Password to access (lock) the device menu. For the value of 0 access lock is disabled.	
4021		0...5	3	Resolution (precision) of additional value displaying – number of decimal places. Range and meaning of value as for register 4015.	
4022		0...11	1	Display unit for additional value displaying. Choice of units as for the main value according to register 4016.	
Individual characteristics					
4023		0, 1	0	Enable individual characteristic for main value. Entering the value of 1 enables individual characteristic for main value.	
4024		2..32	2	Number of individual characteristic points for main value.	
4025		0, 1	0	Enable individual characteristic for additional value. Entering the value of 1 enables individual characteristic for additional value.	
4026		2..32	2	Number of individual characteristic points for additional value.	
Analog output					
4027		0...4	1	Mode of analog output operation.	
				Value	Mode of analog output operation.
				0	Output disabled
				1	Output 4..20 mA
				2	Output 0..20 mA
4028		0...5	1	Selection of analog output control value.	
				Value	Analog output control value.
				0	Measured distance.
				1	Measured distance after scaling – basic value after scaling.
				2	Additional value after scaling.
				3	Temperature value measured by the measuring head.
				4	Current time
5	Counter value				
Alarms					
4029		0...5	1	Control value of alarm no. 1. Selection of value according to register 4028.	
4030		0...5	5	Type of alarm no. 1 operation (see description of alarms)	
				Value	Alarm type
				0	n-on,

				1	n-off,
				2	on,
				3	off,
				4	hon – activated – manual control,
				5	hoff – deactivated – manual control,
4031		0...900	0	Alarm no. 1 delay expressed in seconds before switching to active mode.	
4032		0...900	0	Alarm no. 1 delay expressed in seconds before switching to inactive mode.	
4033		0, 1	0	Enable alarm memory. Entering the value of 1 results in enabling alarm no. 1 memory function.	
4034		0...5	1	Control value of alarm no. 2. Selection of value according to register 4028.	
4035		0...5	5	Type of alarm no. 2 operation (settings as for alarm no. 1).	
4036		0...900	0	Alarm no. 2 delay expressed in seconds before switching to active mode.	
4037		0...900	0	Alarm no. 1 delay expressed in seconds before switching to inactive mode.	
4038		0, 1	0	Enable alarm memory. Entering the value of 1 results in enabling alarm no. 2 memory function.	
Alarms - clearing memory					
4039		0, 1	0	Delete alarm no. 1 memory. Entering the value of 1 deletes saved event of alarm no. 1 occurrence.	
4040		0, 1	0	Delete alarm no. 2 memory. Entering the value of 1 deletes saved event of alarm no. 1 occurrence.	
Clearing minimum and maximum values					
4041		0, 1	0	Delete minimum of main value. Entering the value of 1 results in deleting the value.	
4042		0, 1	0	Delete maximum of main value. Entering the value of 1 results in deleting the value.	
4043		0, 1	0	Delete minimum of additional value. Entering the value of 1 results in deleting the value.	
4044		0, 1	0	Delete maximum of additional value. Entering the value of 1 results in deleting the value.	
4045		0, 1	0	Delete minimum value of temperature measurement. Entering the value of 1 results in deleting the value.	
4046		0, 1	0	Delete maximum value of temperature measurement. Entering the value of 1 results in deleting the value.	
4047		0, 1	0	Clear (reset) the counter.	
Archive					
4048		0, 1	0	Delete events archive.	
4049		0, 1	0	Delete data archive.	
Archive – channel 1					
4050		0...4	0	Archived value	
	Value			Archived value	

				0	Measured distance.
				1	Measured distance after scaling – basic value after scaling.
				2	Additional value after scaling.
				3	Temperature value measured by the measuring head.
				4	Counter value
4051		0...5	0	Value triggering conditional archiving.	
				Value	Value triggering archiving.
				0	Measured distance.
				1	Measured distance after scaling – basic value after scaling.
				2	Additional value after scaling.
				3	Temperature value measured by the measuring head.
				4	Current time
				5	Counter value
4052		0...5	5	Type of archiving triggering in channel no. 1. Types of triggering as for alarms.	
				Value	Triggering type
				0	n-on,
				1	n-off,
				2	on,
				3	off,
				4	hon – activated – manual control,
				5	hoff – deactivated – manual control,
4053		0...900	0	Delay of recording start after triggering event occurrence, expressed in seconds.	
4054		0...900	0	Delay of recording end after triggering event is over, expressed in seconds.	
4055		1...3600	60	Period, archiving frequency in channel no. 1. Specifies the interval, expressed in seconds, between successive records in the archive.	
Archive – channel 2					
4056		0...4	0	Archived value – settings as for channel no. 1.	
4057		0...5	0	Value triggering conditional archiving – settings as for channel no. 1.	
4058		0...5	5	Type of archiving triggering in channel no. 2 – settings as for channel no. 1.	
4059		0...900	0	Delay of recording start after triggering event occurrence, expressed in seconds.	
4060		0...900	0	Delay of recording end after triggering event is over, expressed in seconds.	
4061		1...3600	60	Period, archiving frequency in channel no. 2. Specifies the interval, expressed in seconds, between successive records in the archive.	

Archive – channel 3				
4062		0...4	0	Archived value – settings as for channel no. 1.
4063		0...5	0	Value triggering conditional archiving – settings as for channel no. 1.
4064		0...5	5	Type of archiving triggering in channel no. 3 – settings as for channel no. 1.
4065		0...900	0	Delay of recording start after triggering event occurrence, expressed in seconds.
4066		0...900	0	Delay of recording end after triggering event is over, expressed in seconds.
4067		1...3600	60	Period, archiving frequency in channel no. 3. Specifies the interval, expressed in seconds, between successive records in the archive.
Archive – channel 4				
4068		0...4	0	Archived value – settings as for channel no. 1.
4069		0...5	0	Value triggering conditional archiving – settings as for channel no. 1.
4070		0...5	5	Type of archiving triggering in channel no. 4 – settings as for channel no. 1.
4071		0...900	0	Delay of recording start after triggering event occurrence, expressed in seconds.
4072		0...900	0	Delay of recording end after triggering event is over, expressed in seconds.
4073		1...3600	60	Period, archiving frequency in channel no. 4. Specifies the interval, expressed in seconds, between successive records in the archive.
Archive – channel 5				
4074		0...4	0	Archived value – settings as for channel no. 1.
4075		0...5	0	Value triggering conditional archiving – settings as for channel no. 1.
4076		0...5	5	Type of archiving triggering in channel no. 5 – settings as for channel no. 1.
4077		0...900	0	Delay of recording start after triggering event occurrence, expressed in seconds.
4078		0...900	0	Delay of recording end after triggering event is over, expressed in seconds.
4079		1...3600	60	Period, archiving frequency in channel no. 5. Specifies the interval, expressed in seconds, between successive records in the archive.
4080		0...4	0	Archived value – settings as for channel no. 1.
Archive - downloading				
4081		0...8191	0	Number of archive page to be downloaded and copied to registers from group 5000.

5.7.4.2 Registers 4300 – 4435

Read-only 16-bit registers.

Address	Description	
System parameters		
4300	Software version number.	
4301	ULT20 serial number. Two older bytes of 32-bit serial number.	
4302	ULT20 serial number. Two younger bytes of 32-bit serial number.	
4303	Internal system clock. Two older bytes of 32-bit time counter with resolution 1 millisecond.	
4304	Internal system clock. Two younger bytes of 32-bit counter with resolution 1 millisecond.	
Real-time clock		
4305	Current date - year in YY format.	
4306	Current date - month.	
4307	Current date - day.	
4308	Current time - hour.	
4309	Current time - minutes.	
4310	Current time - seconds.	
4311	Status of internal clock.	
	Value	Description
	0	No errors in clock operation.
	1	Loss of time settings.
	2	Error during clock initiation - damaged clock.
	3	Error during clock setup.
Archive		
4312	Number of archived events in event archive memory.	
4313	Number of archived data records in data archive memory - two older bytes.	
4314	Number of archived data records in data archive memory - two younger bytes.	
Time of powers supply decay and return		
4315	Power supply decay - year	
4316	Power supply decay - month	
4317	Power supply decay - day of month	
4318	Power supply decay - hour	
4319	Power supply decay - minutes	
4320	Power supply decay - seconds	
4321	Power supply return - year	
4322	Power supply return - month	
4323	Power supply return - day of month	
4324	Power supply return - hours	
4325	Power supply return - minutes	
4326	Power supply return - seconds	

Date and time of measured minimum main value occurrence.	
4327	Minimum value of main value – year of occurrence month of occurrence
4328	Minimum value of main value – month of occurrence
4329	Minimum value of main value – day of occurrence
4330	Minimum value of main value – hour of occurrence
4331	Minimum value of main value – minute of occurrence
4332	Minimum value of main value – seconds of occurrence
Date and time of measured maximum main value occurrence.	
4333	Maximum value of main value – year of occurrence
4334	Maximum value of main value – month of occurrence
4335	Maximum value of main value – day of occurrence
4336	Maximum value of main value – hour of occurrence
4337	Maximum value of main value – minute of occurrence
4338	Maximum value of main value – seconds of occurrence
Date and time of measured minimum additional value occurrence.	
4339	Minimum value of additional value – year of occurrence
4340	Minimum value of additional value – month of occurrence
4341	Minimum value of additional value – day of occurrence
4342	Minimum value of additional value – hour of occurrence
4343	Minimum value of additional value – minute of occurrence
4344	Minimum value of additional value – seconds of occurrence
Date and time of measured maximum additional value occurrence.	
4346	Maximum value of additional value – year of occurrence
4347	Maximum value of additional value – month of occurrence
4348	Maximum value of additional value – day of occurrence
4349	Maximum value of additional value – hour of occurrence
4350	Maximum value of additional value – minute of occurrence
4351	Maximum value of additional value – seconds of occurrence
Date and time of occurrence of minimum temperature value measured by measuring head.	
4352	Minimum value of temperature – year of occurrence
4353	Minimum value of temperature – month of occurrence
4354	Minimum value of temperature – day of occurrence
4355	Minimum value of temperature – day of occurrence
4356	Minimum value of temperature – minute of occurrence
4357	Minimum value of temperature – seconds of occurrence
Date and time of occurrence of maximum temperature value measured by measuring head.	
4358	Maximum value of temperature – year of occurrence
4359	Maximum value of temperature – month of occurrence
4360	Maximum value of temperature – day of occurrence
4361	Maximum value of temperature – day of occurrence
4362	Maximum value of temperature – minute of occurrence

4363	Maximum value of temperature – seconds of occurrence
Date and time of occurrence of minimum measured value at auxiliary current input (Reserved)	
4364	Minimum value of current at auxiliary input – year of occurrence
4365	Minimum value of current at auxiliary input – month of occurrence
4366	Minimum value of current at auxiliary input – day of occurrence
4367	Minimum value of current at auxiliary input – day of occurrence
4368	Minimum value of current at auxiliary input – minute of occurrence
4369	Minimum value of current at auxiliary input – seconds of occurrence
Date and time of occurrence of maximum measured value at auxiliary current input (Reserved)	
4370	Maximum value of current at auxiliary input – year of occurrence
4371	Maximum value of current at auxiliary input – month of occurrence
4372	Maximum value of current at auxiliary input – day of occurrence
4373	Maximum value of current at auxiliary input – day of occurrence
4374	Maximum value of current at auxiliary input – minute of occurrence
4375	Maximum value of current at auxiliary input – seconds of occurrence
Date and time of minimum value of supply voltage occurrence.	
4376	Minimum value of supply voltage – year of occurrence
4377	Minimum value of supply voltage – month of occurrence
4378	Minimum value of supply voltage – day of occurrence
4379	Minimum value of supply voltage – day of occurrence
4380	Minimum value of supply voltage – minute of occurrence
4381	Minimum value of supply voltage – seconds of occurrence
Date and time of maximum value of supply voltage occurrence.	
4382	Maximum value of supply voltage – year of occurrence
4383	Maximum value of supply voltage – month of occurrence
4384	Maximum value of supply voltage – day of occurrence
4385	Maximum value of supply voltage – day of occurrence
4386	Maximum value of supply voltage – minute of occurrence
4387	Maximum value of supply voltage – seconds of occurrence
Date and time of minimum value of measuring head supply voltage occurrence (+12 V).	
4388	Minimum value of measuring head supply voltage – year of occurrence
4389	Minimum value of measuring head supply voltage – month of occurrence
4390	Minimum value of measuring head supply voltage – day of occurrence
4391	Minimum value of measuring head supply voltage – day of occurrence
4392	Minimum value of measuring head supply voltage – minute of occurrence
4393	Minimum value of measuring head supply voltage – seconds of occurrence
Date and time of maximum value of measuring head supply voltage occurrence (+12 V).	
4394	Maximum value of measuring head supply voltage – year of occurrence
4395	Maximum value of measuring head supply voltage – month of occurrence
4396	Maximum value of measuring head supply voltage – day of occurrence
4397	Maximum value of measuring head supply voltage – day of occurrence

4398	Maximum value of measuring head supply voltage – minute of occurrence
4399	Maximum value of measuring head supply voltage – seconds of occurrence
Date and time of minimum value of main AC adapter voltage occurrence (+5 V).	
4400	Minimum value of main AC adapter voltage – year of occurrence
4401	Minimum value of main AC adapter voltage – month of occurrence
4402	Minimum value of main AC adapter voltage – day of occurrence
4403	Minimum value of main AC adapter voltage – day of occurrence
4404	Minimum value of main AC adapter voltage – minute of occurrence
4405	Minimum value of main AC adapter voltage – seconds of occurrence
Date and time of maximum value of main AC adapter voltage occurrence (+5 V).	
4406	Maximum value of main AC adapter voltage – year of occurrence
4407	Maximum value of main AC adapter voltage – month of occurrence
4408	Maximum value of main AC adapter voltage – day of occurrence
4409	Maximum value of main AC adapter voltage – day of occurrence
4410	Maximum value of main AC adapter voltage – minute of occurrence
4411	Maximum value of main AC adapter voltage – seconds of occurrence
Date and time of minimum value of internal temperature occurrence.	
4412	Minimum value of internal temperature – year of occurrence
4413	Minimum value of internal temperature – month of occurrence
4414	Minimum value of internal temperature – day of occurrence
4415	Minimum value of internal temperature – day of occurrence
4416	Minimum value of internal temperature – minute of occurrence
4417	Minimum value of internal temperature – seconds of occurrence
Date and time of maximum value of internal temperature occurrence.	
4418	Maximum value of internal temperature – year of occurrence
4419	Maximum value of internal temperature – month of occurrence
4420	Maximum value of internal temperature – day of occurrence
4421	Maximum value of internal temperature – day of occurrence
4422	Maximum value of internal temperature – minute of occurrence
4423	Maximum value of internal temperature – seconds of occurrence
Date and time of minimum value of voltage of battery supplying the clock occurrence	
4424	Minimum value of voltage of battery supplying the clock – year of occurrence
4425	Minimum value of voltage of battery supplying the clock – month of occurrence
4426	Minimum value of voltage of battery supplying the clock – day of occurrence
4427	Minimum value of voltage of battery supplying the clock – day of occurrence
4428	Minimum value of voltage of battery supplying the clock – minute of occurrence
4429	Minimum value of voltage of battery supplying the clock – seconds of occurrence
Date and time of maximum value of voltage of battery supplying the clock occurrence	
4430	Maximum value of voltage of battery supplying the clock – year of occurrence
4431	Maximum value of voltage of battery supplying the clock – month of occurrence
4432	Maximum value of voltage of battery supplying the clock – day of occurrence

4433	Maximum value of voltage of battery supplying the clock – day of occurrence
4434	Maximum value of voltage of battery supplying the clock – minute of occurrence
4435	Maximum value of voltage of battery supplying the clock – seconds of occurrence
Status word bits	
4436	Global bit of configuration damage. Register is set when any of the groups of configuration registers has been damaged.
4437	ULT20 transducer is not calibrated.
4438	Damaged memory of system registers – group 1.000.
4439	Damaged memory of system registers – group 1.500.
4440	Damaged memory of system registers – group 2.500.
4441	Damages configuration registers starting with address 4000.
4442	Damages configuration registers starting with address 7800.
4443	Error of communication with configuration memory.
4444	Error of communication with archive memory.
4445	Error of communication with analog output module.
4446	Real-time clock - loss of settings.
4447	Error of communication with measuring head.
4448	Loss of minimum value according to PAR1.
4449	Loss of maximum value according to PAR1.
4450	Loss of minimum temperature value of the head.
4451	Loss of maximum temperature value of the head.
4452	Loss of minimum value according to PAR2.
4453	Loss of maximum value according to PAR2.
4454	Loss of process data (counter, number of pulses to be generated at binary output, active page displayed on the LCD, data on archive filling).
4455	Wrong configuration of analog output. Lower and upper threshold set at the same value.
4456	Wrong configuration of individual characteristic according to PAR1.
4457	Wrong configuration of individual characteristic according to PAR2.
4458	Activation of AL1 alarm relay.
4459	Activation of AL2 alarm relay.
4460	Exceeded range at auxiliary analog output (service event).
4461	Exceeded range of supply voltage – voltages outside the range of operation.
4462	Supply voltage of the head outside the the range of normal operation (e.g. due to too low supply voltage).
4463	Main supply voltage outside permissible range.
4464	Exceeded permissible operation temperature range.
4465	Wrong value of the voltage of battery supplying the internal real-time clock.
4466	Loss of process data (counter, number of pulses to be generated at binary output, active page displayed on the LCD, data on archive filling).
4467	Wrong configuration of analog output. Lower and upper threshold set at the same value.
4468	Wrong configuration of individual characteristic according to PAR1.
4469	Wrong configuration of individual characteristic according to PAR2.

4470	AL1 relay activated.
4471	AL2 relay activated.
4472	Exceeded range at auxiliary analog output (service event).
4473	Exceeded range of supply voltage – voltages outside the range of operation.
4474	Supply voltage of the head outside the the range of normal operation (e.g. due to too low supply voltage).
4475	Main supply voltage outside permissible range.
4476	Exceeded permissible operation temperature range.
4477	Wrong value of the voltage of battery supplying the internal real-time clock.

5.7.4.3 Registers 5000 – 5272

Read-only 16-bit archive registers.

Address	Description
5000	Number of memory page whose data is placed in subsequent registers (starting from register 5009).
5001	Position of the beginning of event archive (older 16 bits)
5002	Position of the beginning of event archive (younger 16 bits)
5003	Position of the end of event archive (older 16 bits)
5004	Position of the end of event archive (younger 16 bits)
5005	Position of the beginning of data archive (older 16 bits)
5006	Position of the beginning of data archive (younger 16 bits)
5007	Position of the end of data archive (older 16 bits)
5008	Position of the end of data archive (younger 16 bits)
5009	Two first bytes of data from memory page indicated in register 5000.
...	...
5272	Two last bytes of data from memory page indicated in register 5000.

5.7.4.4 Registers 7500 – 7533 and 8000 – 8065

32-bit and corresponding to them 16-bit registers with measured and calculated data. In the address field the given address is for 32-bit variables float type or in the second column for the values contained in the two 16-bit registers, where the value stored in the two registers is a float.

Address (registers 32 bit float)	Address (Value in 2 registers 16-bit)	Description
7500	8000	Device ID - code to response the MODBUS 17 function.
7501	8002	Expected value at analog output expressed in mA.
7502	8004	Degree of analog output VU.
7503	8006	Current time in hh.mmss format.
7504	8008	Minimum measured value of main value.

7505	8010	Maximum measured value of main value.
7506	8012	Current measured main value.
7507	8014	Instantaneous value of measured main value - not averaged value.
7508	8016	Main value recalculated by individual characteristic (acc. to <i>PAR1</i>).
7509	8018	Minimum main value recalculated bu additional individual characteristic – minimum additional value.
7510	8020	Maximum main value recalculated bu additional individual characteristic – maximum additional value.
7511	8022	Additional value – main value recalculated by individual characteristic (acc. to <i>PAR2</i>).
7512	8024	Minimum value of measuring head temperature.
7513	8026	Maximum value of measuring head temperature.
7514	8028	Current value of measuring head temperature.
7515	8030	Content of the counter.
7516	8032	Minimum measured value at auxiliary current input.
7517	8034	Maximum measured value at auxiliary current input.
7518	8036	Minimum value of power supply.
7519	8038	Maximum value of power supply.
7520	8040	Current value of power supply.
7521	8042	Minimum value of voltage supplying measuring head.
7522	8044	Maximum value of voltage supplying measuring head.
7523	8046	Current value of voltage supplying measuring head.
7524	8048	Minimum value of voltage of main AC adapter (+5V).
7525	8050	Maximum value of voltage of main AC adapter (+5V).
7526	8052	Current value of voltage of main AC adapter (+5V).
7527	8054	Minimum value of internal temperature.
7528	8056	Maximum value of internal temperature.
7529	8058	Current value of internal temperature.
7530	8060	Minimum value of voltage of backup battery.
7531	8062	Maximum value of voltage of backup battery.
7532	8064	Current value of voltage of backup battery.

5.7.4.5 Registers 7800 – 7949 and 8200 – 8498

32-bit and corresponding to them 16-bit registers with configuration parameters. The address given in address field is the address for 32-bit variables, in brackets there is address to access data placed in two subsequent 16-bit registers.

Address (registers 32 bit float)	Address (Value in 2 registers 16-bit)	Symbol	Acceptable values	Default	Description
Parameters of analog output					
7800	8200	<i>AnIn Lo</i>	-99999...999999	0	Value controlling analog output for which the output signal must reach minimum value.
7801	8202	<i>AnIn Hi</i>	-99999...999999	5	Value controlling analog output for which the output signal must reach maximum value.
7802	8204	<i>AnManVal</i>	0...24	0	Value of analog output current during manual control.
Configuration of alarms					
7803	8206	<i>OverLo AI</i>	-99999...999999	1	Alarm no. 1 – lower control value changing the state of relay contacts.
7804	8208	<i>OverHi AI</i>	-99999...999999	3	Alarm no. 1 – upper control value changing the state of relay contacts.
7805	8210	<i>OverLo AI</i>	-99999...999999	1	Alarm no. 2 – lower control value changing the state of relay contacts.
7806	8212	<i>OverHi AI</i>	-99999...999999	3	Alarm no. 2 – upper control value changing the state of relay contacts.
Minimum and maximum displayed value					
7807	8214	<i>Over Lo</i>	-99999...999999	-99999	Minimum value of displayed main value acc. to <i>PAR1</i> . Lower overrun is displayed below this value.
7808	8216	<i>Over Hi</i>	-99999...999999	999999	Maximum value of displayed main value acc. to <i>PAR1</i> . Upper overrun is displayed below this value.
7809	8218	<i>Over Lo</i>	-99999...999999	-99999	Minimum value of displayed additional value acc. to <i>PAR2</i> . Lower overrun is displayed below this value.
7810	8220	<i>Over Lo</i>	-99999...999999	999999	Maximum value of displayed additional value acc. to <i>PAR2</i> . Lower overrun is displayed below this value.
Binary output					
7811	8222	<i>Pulse K</i>	0...999999	1	Pulse weight for counter binary output. When counter reaches the specified value a pulse is generated at binary output.

Thresholds of conditional archiving triggering.					
7812	8224	<i>Trig.Lo</i>	-99999...999999	1	Channel 1 of conditional archiving – lower threshold of change of recording channel state (<i>Trig.Lo</i>).
7813	8226	<i>Trig.Hi</i>	-99999...999999	3	Channel 1 of conditional archiving – upper threshold of change of recording channel state (<i>Trig.Hi</i>).
7814	8228	<i>Trig.Lo</i>	-99999...999999	1	Channel 2 of conditional archiving - lower threshold of change of recording channel state (<i>Trig.Lo</i>).
7815	8230	<i>Trig.Hi</i>	-99999...999999	3	Channel 2 of conditional archiving - upper threshold of change of recording channel state (<i>Trig.Hi</i>).
7816	8232	<i>Trig.Lo</i>	-99999...999999	1	Channel 3 of conditional archiving - lower threshold of change of recording channel state (<i>Trig.Lo</i>).
7817	8234	<i>Trig.Hi</i>	-99999...999999	3	Channel 3 of conditional archiving - upper threshold of change of recording channel state (<i>Trig.Hi</i>).
7818	8236	<i>Trig.Lo</i>	-99999...999999	1	Channel 4 of conditional archiving - lower threshold of change of recording channel state (<i>Trig.Lo</i>).
7819	8238	<i>Trig.Hi</i>	-99999...999999	3	Channel 4 of conditional archiving - upper threshold of change of recording channel state (<i>Trig.Hi</i>).
7820	8240	<i>Trig.Lo</i>	-99999...999999	1	Channel 5 of conditional archiving - lower threshold of change of recording channel state (<i>Trig.Lo</i>).
7821	8242	<i>Trig.Hi</i>	-99999...999999	3	Channel 5 of conditional archiving - upper threshold of change of recording channel state (<i>Trig.Hi</i>).
Individual characteristic points - main value measured according to <i>PAR1</i>					
7822	8244	<i>X1</i>	-99999...999999	1	Point no. 1, value x.
7823	8246	<i>Y1</i>	-99999...999999	1	Point no. 1, value y.
7824	8248	<i>X2</i>	-99999...999999	2	Point no. 2, value x.
7825	8250	<i>Y2</i>	-99999...999999	2	Point no. 2, value y.
7826	8252	<i>X3</i>	-99999...999999	3	Point no. 3, value x.
7827	8254	<i>Y3</i>	-99999...999999	3	Point no. 3, value y.
7828	8256	<i>X4</i>	-99999...999999	4	Point no. 4, value x.
7829	8258	<i>Y4</i>	-99999...999999	4	Point no. 4, value y.
7830	8260	<i>X5</i>	-99999...999999	5	Point no. 5, value x.
7831	8262	<i>Y5</i>	-99999...999999	5	Point no. 5, value y.
7832	8264	<i>X6</i>	-99999...999999	6	Point no. 6, value x.
7833	8266	<i>Y6</i>	-99999...999999	6	Point no. 6, value y.
7834	8268	<i>X7</i>	-99999...999999	7	Point no. 7, value x.
7835	8270	<i>Y7</i>	-99999...999999	7	Point no. 7, value y.
7836	8272	<i>X8</i>	-99999...999999	8	Point no. 8, value x.

7837	8274	Y8	-99999...999999	8	Point no. 8, value y.
7838	8276	X9	-99999...999999	9	Point no. 9, value x.
7839	8278	Y9	-99999...999999	9	Point no. 9, value y.
7840	8280	X10	-99999...999999	10	Point no. 10, value x.
7841	8282	Y10	-99999...999999	10	Point no. 10, value y.
7842	8284	X11	-99999...999999	11	Point no. 11, value x.
7843	8286	Y11	-99999...999999	11	Point no. 11, value y.
7844	8288	X12	-99999...999999	12	Point no. 12, value x.
7845	8290	Y12	-99999...999999	12	Point no. 12, value y.
7846	8292	X13	-99999...999999	13	Point no. 13, value x.
7847	8294	Y13	-99999...999999	13	Point no. 13, value y.
7848	8296	X14	-99999...999999	14	Point no. 14, value x.
7849	8298	Y14	-99999...999999	14	Point no. 14, value y.
7850	8300	X15	-99999...999999	15	Point no. 15, value x.
7851	8302	Y15	-99999...999999	15	Point no. 15, value y.
7852	8304	X16	-99999...999999	16	Point no. 16, value x.
7853	8306	Y16	-99999...999999	16	Point no. 16, value y.
7854	8308	X17	-99999...999999	17	Point no. 17, value x.
7855	8310	Y17	-99999...999999	17	Point no. 17, value y.
7856	8312	X18	-99999...999999	18	Point no. 18, value x.
7857	8314	Y18	-99999...999999	18	Point no. 18, value y.
7858	8316	X19	-99999...999999	19	Point no. 19, value x.
7859	8318	Y19	-99999...999999	19	Point no. 19, value y.
7860	8320	X20	-99999...999999	20	Point no. 20, value x.
7861	8322	Y20	-99999...999999	20	Point no. 20, value y.
7862	8324	X21	-99999...999999	21	Point no. 21, value x.
7863	8326	Y21	-99999...999999	21	Point no. 21, value y.
7864	8328	X22	-99999...999999	22	Point no. 22, value x.
7865	8330	Y22	-99999...999999	22	Point no. 22, value y.
7866	8332	X23	-99999...999999	23	Point no. 23, value x.
7867	8334	Y23	-99999...999999	23	Point no. 23, value y.
7868	8336	X24	-99999...999999	24	Point no. 24, value x.
7869	8338	Y24	-99999...999999	24	Point no. 24, value y.
7870	8340	X25	-99999...999999	25	Point no. 25, value x.
7871	8342	Y25	-99999...999999	25	Point no. 25, value y.
7872	8344	X26	-99999...999999	26	Point no. 26, value x.
7873	8346	Y26	-99999...999999	26	Point no. 26, value y.
7874	8348	X27	-99999...999999	27	Point no. 27, value x.
7875	8350	Y27	-99999...999999	27	Point no. 27, value y.
7876	8352	X28	-99999...999999	28	Point no. 28, value x.
7877	8354	Y28	-99999...999999	28	Point no. 18, value y.

7878	8356	X29	-99999...999999	29	Point no. 29, value x.
7879	8358	Y29	-99999...999999	29	Point no. 29, value y.
7880	8360	X30	-99999...999999	30	Point no. 30, value x.
7881	8362	Y30	-99999...999999	30	Point no. 30, value y.
7882	8364	X31	-99999...999999	31	Point no. 31, value x.
7883	8366	Y31	-99999...999999	31	Point no. 31, value y.
7884	8368	X32	-99999...999999	32	Point no. 32, value x.
7885	8370	Y32	-99999...999999	32	Point no. 32, value y.
Individual characteristic points - main value measured according to <i>PAR2</i>					
7886	8372	X1	-99999...999999	1	Point no. 1, value x.
7887	8374	Y1	-99999...999999	1	Point no. 1, value y.
7888	8376	X2	-99999...999999	2	Point no. 2, value x.
7889	8378	Y2	-99999...999999	2	Point no. 2, value y.
7890	8380	X3	-99999...999999	3	Point no. 3, value x.
7891	8382	Y3	-99999...999999	3	Point no. 3, value y.
7892	8384	X4	-99999...999999	4	Point no. 4, value x.
7893	8386	Y4	-99999...999999	4	Point no. 4, value y.
7894	8388	X5	-99999...999999	5	Point no. 5, value x.
7895	8390	Y5	-99999...999999	5	Point no. 5, value y.
7896	8392	X6	-99999...999999	6	Point no. 6, value x.
7897	8394	Y6	-99999...999999	6	Point no. 6, value y.
7898	8396	X7	-99999...999999	7	Point no. 7, value x.
7899	8498	Y7	-99999...999999	7	Point no. 7, value y.
7900	8400	X8	-99999...999999	8	Point no. 8, value x.
7901	8402	Y8	-99999...999999	8	Point no. 8, value y.
7902	8404	X9	-99999...999999	9	Point no. 9, value x.
7903	8406	Y9	-99999...999999	9	Point no. 9, value y.
7904	8408	X10	-99999...999999	10	Point no. 10, value x.
7905	8410	Y10	-99999...999999	10	Point no. 10, value y.
7906	8412	X11	-99999...999999	11	Point no. 11, value x.
7907	8414	Y11	-99999...999999	11	Point no. 11, value y.
7908	8416	X12	-99999...999999	12	Point no. 12, value x.
7909	8418	Y12	-99999...999999	12	Point no. 12, value y.
7910	8420	X13	-99999...999999	13	Point no. 13, value x.
7911	8422	Y13	-99999...999999	13	Point no. 13, value y.
7912	8424	X14	-99999...999999	14	Point no. 14, value x.
7913	8426	Y14	-99999...999999	14	Point no. 14, value y.
7914	8428	X15	-99999...999999	15	Point no. 15, value x.
7915	8430	Y15	-99999...999999	15	Point no. 15, value y.
7916	8432	X16	-99999...999999	16	Point no. 16, value x.
7917	8434	Y16	-99999...999999	16	Point no. 16, value y.

7918	8436	X17	-99999...999999	17	Point no. 17, value x.
7919	8438	Y17	-99999...999999	17	Point no. 17, value y.
7920	8440	X18	-99999...999999	18	Point no. 18, value x.
7921	8442	Y18	-99999...999999	18	Point no. 18, value y.
7922	8444	X19	-99999...999999	19	Point no. 19, value x.
7923	8446	Y19	-99999...999999	19	Point no. 19, value y.
7924	8448	X20	-99999...999999	20	Point no. 20, value x.
7925	8450	Y20	-99999...999999	20	Point no. 20, value y.
7926	8452	X21	-99999...999999	21	Point no. 21, value x.
7927	8454	Y21	-99999...999999	21	Point no. 21, value y.
7928	8456	X22	-99999...999999	22	Point no. 22, value x.
7929	8458	Y22	-99999...999999	22	Point no. 22, value y.
7930	8460	X23	-99999...999999	23	Point no. 23, value x.
7931	8462	Y23	-99999...999999	23	Point no. 23, value y.
7932	8464	X24	-99999...999999	24	Point no. 24, value x.
7933	8466	Y24	-99999...999999	24	Point no. 24, value y.
7934	8468	X25	-99999...999999	25	Point no. 25, value x.
7935	8470	Y25	-99999...999999	25	Point no. 25, value y.
7936	8472	X26	-99999...999999	26	Point no. 26, value x.
7937	8474	Y26	-99999...999999	26	Point no. 26, value y.
7938	8476	X27	-99999...999999	27	Point no. 27, value x.
7939	8478	Y27	-99999...999999	27	Point no. 27, value y.
7940	8480	X28	-99999...999999	28	Point no. 28, value x.
7941	8482	Y28	-99999...999999	28	Point no. 18, value y.
7942	8484	X29	-99999...999999	29	Point no. 29, value x.
7943	8486	Y29	-99999...999999	29	Point no. 29, value y.
7944	8488	X30	-99999...999999	30	Point no. 30, value x.
7945	8490	Y30	-99999...999999	30	Point no. 30, value y.
7946	8492	X31	-99999...999999	31	Point no. 31, value x.
7947	8494	Y31	-99999...999999	31	Point no. 31, value y.
7948	8496	X32	-99999...999999	32	Point no. 32, value x.
7949	8498	Y32	-99999...999999	32	Point no. 32, value y.

5.8 USB interface

ULT20 transducers have a built-in USB interface with connector at the front panel in the form of a mini-USB slot. The transducer are slave devices on USB bus.

After connection the transducer to the computer it is automatically detected by the operating system and drivers are installed automatically. On older systems you may need to download the drivers from LUMEL S.A. website. After installing the drivers an additional serial port appears in the system. Standard communication parameters with the transducer are shown below. MODBUS RTU is used for communication with the transducer, and the map

of registers is the same as for RS-485 interface. The interface parameters are set permanently and cannot be changed.

Transmission parameters:

- Address: 1.
- Transmission speed: 1 M [b/s].
- Operating mode: RTU with 8n2 frame.

Note: Due to the common map of registers the User should not perform simultaneous readout of the archive via RS-485 and USB interface, because it can lead to data distortion.

6 Error codes

ULT20 transducers are equipped with numerous built-in diagnostic functions and settings to reduce display. Accordingly, information about diagnosed error, event or a fault may appear on the display and in the status registers. Following are the possible messages and their potential causes.

	<p>Initiation and stabilization of the measuring head takes place. The symbol appears when the transducer is started, and if the measured object is too close to the measuring head. Initialization process may occur during the measurement, if the measurement is very unstable.</p>
	<p>Upper overrun - the measurement value exceeds the measurement range, or the measured value exceeds the set value <i>Over Hi</i>.</p>
	<p>Lower overrun - the measurement value is smaller than the lower limit of the range, or the measured value is smaller than the set value of the parameter <i>Over Lo</i>.</p>
	<p>Error of data reading from measuring head. If the error occurs continuously, check the power supply voltage level. If the supply voltage falls within the range, you should contact the Service Department.</p>
	<p>Error of auxiliary (service) input. If the error occurs continuously contact the Service Department.</p>
	<p>Incorrect supply voltage - voltage out of range. Inspect the quality of the supplied power.</p>
	<p>Incorrect voltage of measuring head supply. Check whether there has been mechanical damage to the head. Please contact our service department.</p>

<p>01 02 ---- 08:32:13</p> <div style="border: 2px solid black; padding: 5px; width: fit-content;"> <p>Diag.5V Error</p> </div>	<p>Faulty internal power supply unit. Please contact our service department.</p>
<p>01 02 ---- 08:38:13</p> <div style="border: 2px solid black; padding: 5px; width: fit-content;"> <p>Diag.T Error</p> </div>	<p>Exceeded the transducer operating temperature. The error occurs in the case of exceeding the allowable operating temperature, which is measured on the board of control processor.</p>
<p>01 02 ---- 08:39:44</p> <div style="border: 2px solid black; padding: 5px; width: fit-content;"> <p>Diag.Bat Error</p> </div>	<p>Clock backup battery voltage is too low. If the message is displayed continuously and even after the power is not interrupted, the service department should be contacted to replace the internal backup battery.</p>

7 Technical data

Measurement

Range of distance measurement:	0.5...8 m (see note below)
Beam width	12 °
Ultrasound frequency	50 kHz
Resolution of measurement:	0.001 m
Measurement basic error:	±1 % of the range

The **measuring range** is strongly dependent on the environment in which the measurements are made and the surface from which the ultrasonic wave is reflected. a typical reduction of the measuring range depending on the suppression of the ultrasonic wave is shown in Figure 2.

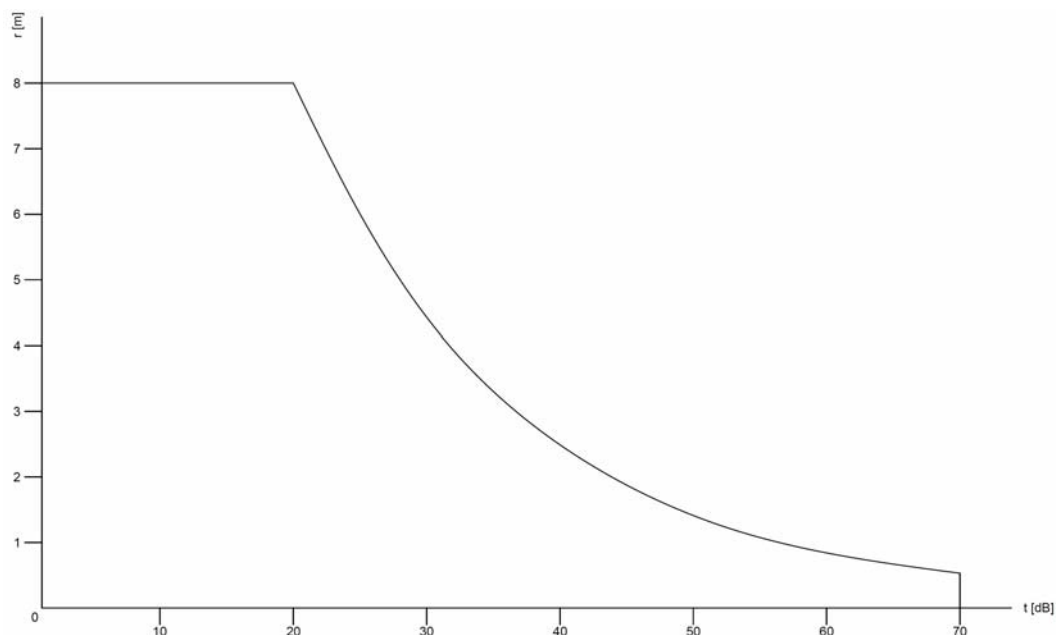

Fig. 24. Change of the measuring range r depending on the damping t of the measurement environment.

Typical damping for a given environment (reflective medium) is summarized in the table below.

	Typical attenuation [dB]
Fluid	
Calm surface	0
Wavy surface	from 5 up to 10
Strong turbulence	from 10 up to 20
Granular	
Hard, porous	40
Soft with strong damping (e.g. peat)	from 40 up to 60
Dust	
Low dust	ca. 5
Large dust	from 5 up to 20

Analog output

Output signal:	0/4...20 mA
Maximum value at the output	24 mA
Basic error:	±0.2 % of the range
Error resulting from ambient temperature changes	50 % of the basic error / 10K

Alarm outputs

Relay outputs with NO contact, maximum load 100 mA / 300 V a.c./d.c

Binary outputs: transistor NPN, $U_{max} = 50 \text{ V}$; $I_{max} = 50 \text{ mA}$; $R_s = 100\Omega$.

Nominal operating conditions:

Power supply:	12.. <u>24</u> ..40 V d.c.
Power consumption:	< 4W
Operating temperature:	-20.. <u>23</u> ..55 °C (do not expose the transducer to direct sunlight)
Storage temperature:	-25..70 °C
Humidity:	< 95% (water vapor condensation is not permissible)
Operating position:	any

Degree of protection:	IP65 acc. to EN 60529
Weight:	
Dimensions:	According to Fig. 2.

Electromagnetic compatibility

Immunity to electromagnetic interference:	Acc. to EN 61000-6-2
Emission of electromagnetic interference:	Acc. to EN 61000-6-4

Safety requirements according to EN 61010-1 standard

Isolation between circuits:	basic
Installation category	III
Pollution level	2
Maximum operating voltage relative to earth	50 V (all circuits apart from alarm circuits) 300 V for alarm circuits.
Altitude	< 2000 m

8 Ordering code

Ordering code

	ULT20-	XX	X	X
Version:				
standard		00		
special*		XX		
Language:				
Polish			P	
English			E	
other*			X	
Acceptance tests:				
without additional requirements				0
with additional Quality Tests				1
acc. to customer's requirements				X

* after agreement with the manufacturer



LUMEL S.A.

ul. Sulechowska 1, 65-022 Zielona Góra, POLAND

tel.: +48 68 45 75 100, fax +48 68 45 75 508

www.lumel.com.pl

Export department:

tel.: (+48 68) 45 75 139, 45 75 233, 45 75 321, 45 75 386

fax.: (+48 68) 32 54 091

e-mail: export@lumel.com.pl